

**LIONEL**  
ELECTRIC  
**TRAINmaster**<sup>®</sup>  
**TRAINS**

C · O · M · M · A · N · D

***The complete guide  
to command control***

***Designed for the future of model railroading  
by Lionel Trains and Liontech***

# Introduction

## Welcome to command control

---

The way you experience model railroading is about to change forever. Run *many* locomotives on a single track, simultaneously and independently. Throw switches and activate accessories by remote. Experience performance in ways you never thought possible. And do all of this from the palm of your hand.

The old rules are history. With your purchase of the Train-

Master Command Base, Lionel railroading is easier—and more fun—than ever before. TrainMaster Command gives you the power to operate most locomotives, switches, and accessories with the CAB-1 remote. Railsounds II-equipped locomotives do more. Even your layout is easier to wire.

Your TrainMaster Command Base holds the key to this brave

## Table of contents

---

### Introduction

<i>Using this manual.....</i>	<i>4</i>
<i>Preparing your railroad for TrainMaster Command.....</i>	<i>4</i>

### The Command Base

<i>Installing the Command Base.....</i>	<i>5</i>
<i>Command control operations.....</i>	<i>6</i>
<i>Command Base compatibility.....</i>	<i>6</i>
<i>Programming ID#s for your Command-equipped locomotives.....</i>	<i>7</i>
<i>Addressing locomotives.....</i>	<i>8</i>
<i>Sending basic commands to locomotives with CAB-1.....</i>	<i>8</i>
<i>Tuning your locomotive's performance.....</i>	<i>9</i>
<i>Sending numeric commands to locomotives.....</i>	<i>9</i>

### Switches

<i>Controlling your railroad's switches with SC-1.....</i>	<i>10</i>
<i>Connecting switches to SC-1.....</i>	<i>10</i>
<i>Programming SC-1 switch numbers.....</i>	<i>11</i>
<i>Controlling switches with CAB-1.....</i>	<i>12</i>
<i>Notes on AUX1 and AUX2 definitions.....</i>	<i>12</i>
<i>Creating routes around your railroad.....</i>	<i>13</i>
<i>Activating routes.....</i>	<i>14</i>
<i>Clearing routes.....</i>	<i>14</i>

### Accessories

<i>Connecting accessories to SC-1.....</i>	<i>15</i>
<i>Programming SC-1 accessory numbers.....</i>	<i>16</i>
<i>Controlling accessories with CAB-1.....</i>	<i>16</i>

### PowerMaster and command control

<i>Controlling track power with PowerMaster.....</i>	<i>17</i>
<i>Controlling accessories with PowerMaster.....</i>	<i>17</i>
<i>Limiting PowerMaster's output.....</i>	<i>18</i>

### Power Sources

<i>Choosing the right power source.....</i>	<i>19</i>
---	-----------

---

new world. Choose your command with CAB-1, and the Command Base sends your wish to the Command-equipped locomotive or SC-1 switch controller (sold separately) you've just called into action, bringing it to life.

TrainMaster Command is standard equipment on many new-generation Lionel locomotives. These locomotives oper-

ate independently on the same track with other Lionels, feature enhanced Railsounds II effects, and include new illumination and smoke effect controls. They are without question the most technologically advanced trains ever made.

TrainMaster Command. Everything you've ever wanted from your Lionels.

---

### ***Powering your railroad***

<b><i>Solutions for a power-hungry railroad.....</i></b>	<b><i>20</i></b>
--	------------------

### ***Advanced operating techniques***

<b><i>Building lash-ups.....</i></b>	<b><i>22</i></b>
<b><i>Addressing lash-ups.....</i></b>	<b><i>24</i></b>
<b><i>Sending basic commands to lash-ups with CAB-1.....</i></b>	<b><i>24</i></b>
<b><i>Sending numeric commands to lash-ups.....</i></b>	<b><i>25</i></b>
<b><i>Removing locomotives from lash-ups.....</i></b>	<b><i>25</i></b>
<b><i>Lash-up problemsolving.....</i></b>	<b><i>26</i></b>
<b><i>Notes on lash-ups.....</i></b>	<b><i>27</i></b>
<b><i>Tuning lash-up performance.....</i></b>	<b><i>27</i></b>
<b><i>Transitional command control with ZW transformers.....</i></b>	<b><i>28</i></b>
<b><i>Transitional command control with PowerMasters.....</i></b>	<b><i>30</i></b>
<b><i>"Sticky" keys.....</i></b>	<b><i>32</i></b>

### ***Command control on your railroad***

<b><i>Recommend layout modifications.....</i></b>	<b><i>34</i></b>
<b><i>Bulb replacement chart.....</i></b>	<b><i>34</i></b>

### ***Base-computer communications***

<b><i>Using the Base's serial port.....</i></b>	<b><i>36</i></b>
<b><i>General command format.....</i></b>	<b><i>36</i></b>
<b><i>Command set.....</i></b>	<b><i>37</i></b>
<b><i>Examples.....</i></b>	<b><i>40</i></b>

### ***Problemsolving***

<b><i>Answers to questions.....</i></b>	<b><i>41</i></b>
---	------------------

### ***Appendix***

<b><i>Phasing power supplies.....</i></b>	<b><i>45</i></b>
<b><i>For more information.....</i></b>	<b><i>45</i></b>
<b><i>Glossary.....</i></b>	<b><i>46</i></b>
<b><i>Index.....</i></b>	<b><i>47</i></b>
<b><i>FCC statement.....</i></b>	<b><i>48</i></b>

# Introduction

## Using this manual

---

We designed this manual to give you more than just a solid start in command control. There's detailed discussion as you learn more, so you'll find plenty of helpful information, no matter what your level of expertise.

Getting started is easy. Just go section by section. For additional information, refer to smaller-print sections marked *Detail*.

### Example

Most important are *Example* boxes. Each is designed to make learning TrainMaster Command quick and easy. Read the text, then press the button commands listed in the Example. Before you know it, you'll be oper-

ating locomotives, switches, and accessories from CAB-1's keypad like a pro.

There's even a glossary to define the terms covered in the manual. If a word or concept is new to you, look it up. The index helps you locate subjects by referencing key words.

Go through each example step by step, repeating the commands. You can't "hurt" the system by pressing the wrong button. TrainMaster Command is more than just a sophisticated way of operating Lionel trains—it's also a rugged example of modern technology.

The only rule: *have fun*.

## Preparing your railroad for TrainMaster Command

---

Any three-rail, alternating current-powered model railroad can become a Lionel TrainMaster Command railroad. Before you install the Command Base, do these things.

First, make sure there are no short circuits *anywhere* on your railroad. Second, make sure all power supplies are in phase. See the Appendix on page 45 for complete instructions on phasing power supplies. Finally, consider everything con-

nected to the track: switches, bulbs, operating cars, illuminated cars, and more.

TrainMaster Command operates on constant, high voltage, so some bulbs may burn out prematurely. If they do, replace them with 18-volt bulbs. See the Bulb Replacement Chart on page 34. Remove or disconnect items you believe may not benefit from constant voltage.



# The Command Base

## Installing the Command Base



Plug the wallpack's cable into the Command Base power input, then plug the wallpack into a properly grounded wall outlet (110 volts, 50/60 cycles).



Connect a wire between the Command Base's binding post and the common (U) terminal on all PowerMasters or ZW transformers powering your track. You can also connect the wire between the Command Base and the outside rail of your track. (Connect the wire to both outside rails if you use hi-rail track.)

You need a CAB-1 remote (sold separately) to operate the Command Base. For more information, refer to the Owner's Manual that comes packaged with CAB-1 (71-2867-250).

To install the Command Base, plug the wallpack power cable into the Base input. Plug the wallpack into a standard wall outlet (110 volts, 50 or 60 cycles). The outlet must be properly grounded. The Base's top-mounted green light will illuminate. The Command Base doesn't have an on/off switch, so you may leave the Command Base on at all times. If you prefer to turn it off after operating sessions, use a power strip with a circuit breaker and on/off switch. Doing so lets you electrify all transformers and the Command Base at once.

### Note!

COMMAND BASE WALLPACK. Do not use the Command Base's wallpack to power any other device. Its three-prong plug is unique.

Next, connect a wire between the Command Base binding post and the common (U) terminal on all PowerMasters or ZW transformers powering your track. Or, connect the wire to your track's outside rail at any convenient location. *You've just installed TrainMaster Command on your railroad.* Be sure the outside (common) rail is electrically continuous throughout your entire layout—this enables unimpeded communication around the track plan. If your layout has block control, make sure only the center (or "hot") rail is insulated with insulating pins at block boundaries. Insulating both outside rails at block boundaries will obstruct the Command Base's signals.

### Note!

FIRST-TIME STARTUPS. Before you begin operations, read this Note. The first time you operate a Command-equipped locomotive, be sure the Command Base is ON before you place the locomotive on track. *Then bring up track power.* When the Base is ON, your Command-equipped Lionels instantly know they're on a TrainMaster Command railroad. If the Base is OFF, the locomotive will operate like an ordinary engine when power is applied. See the next page for proper start-ups using either Lionel ZW transformers or PowerMasters.

# The Command Base

## Command control operations

### For railroads using ZW or equivalent power supplies

**Command Base ON**

**Command-equipped locomotives only**

**All Command-equipped locomotives' reverse unit control switches set to RUN**

**Place Command-equipped Lionel on track**

**Apply track power:**



**Power up ZW track output to FULL**

**Address your Command-equipped Lionel with CAB-1:**



**Press ENG**



**Press the locomotive's ID#**

**Throttle up or press any command button**

**Maintain high track voltage from your ZW transformer whenever you're running Command-equipped Lionels**

**To place additional Command-equipped Lionels on track—or to remove those already on track:**



**Power down ZW track output**

**Restore track power by setting ZW output to FULL**

### For railroads using PowerMasters

**Command Base ON**

**All PowerMaster CMD/CONV switches on CMD**

**Command-equipped locomotives only**

**All Command-equipped locomotives' reverse unit control switches set to RUN**

**Place Command-equipped Lionel on track**

**Apply track power:**



**Press TR**



**Press the PowerMaster ID#**



**Press BOOST**

**Address your Command-equipped Lionel with CAB-1:**



**Press ENG**



**Press the locomotive's ID#**

**Throttle up or press any command button**

**To place additional Command-equipped Lionels on track—or to remove those already on track:**



**Press TR**



**Press the PowerMaster ID#**



**Press AUX1**



**Press 0**

**PowerMaster output is OFF; restore with BOOST**

## Command Base compatibility

TrainMaster Command offers full compatibility with older Lionel locomotives *and* locomotives made by other manufacturers. Some other manufacturers offer locomotives designed for special control from a Lionel ZW transformer. TrainMaster Command provides a simple way to use these locomotives on the same track

with Lionel Command-equipped products. See page 28 of this manual. Just use your ZW transformer to directly control others manufacturers' products. Your only limitation—the stationary control of ZWs as compared with the workaround control and features of Lionel TrainMaster Command.

# Command-equipped locomotives

## Programming ID#s for your Command-equipped locomotives

**Example** Assign an engine ID# to Santa Fe 2343 on Track #1

**Command Base ON**

**Lionel transformers on FULL or PowerMasters set to COMM**

**Slide the locomotive reverse unit control switch to PROGRAM**

**Place locomotive on track**

**Turn PowerMaster-controlled track power on:**



**Press BOOST**

**Program Engine #23:**



**Press ENG**



**Press 23 (the ID#)**



**Press SET (under CAB-1 panel)**

**Hear horn/whistle sound (or see the headlight flash if Railsounds II is OFF)**

**Slide the reverse unit control switch to RUN**

**Your engine remembers its ID# forever; change it any time—just repeat these steps**

Every Command-equipped locomotive comes factory-programmed as "Engine #1." You may wish to assign a new ID#, using any number from 1 through 99. To make it easy, use part of the locomotive cab number. For example, name your Lionel F3 no. 2343 "23" or "43." We use 23 in our example.

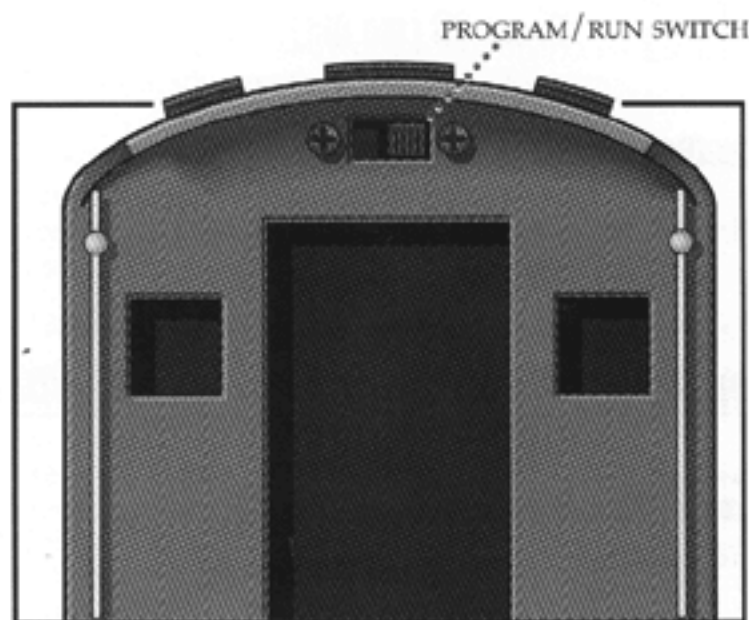

*Slide the PROGRAM/RUN switch on your Command-equipped locomotive to PROGRAM. See your locomotive's owner's manual for the switch location and settings.*

Here's how you give a Command-equipped locomotive its new ID#. Make sure the Command Base is ON. Refer to the Command-equipped locomotive owner's manual(s) for reverse unit control switch locations. Holding the locomotive, slide its control switch to the PROGRAM setting. Place the locomotive on track and power up your railroad.

Using CAB-1, press ENG, the ID# (any number 1 to 99), then press the SET button located under the removable panel on CAB-1. Hear the horn or whistle blow (or see the headlight flash, if Railsounds II is OFF). This confirms your new ID#. Slide the reverse unit control switch back to RUN and you're ready to go.

Want to change your locomotive's ID#? Just repeat these steps *any time*.



# Command-equipped locomotives

## Addressing locomotives

### Example *address Engine #23*

ENG

Press ENG

2 3

Press 23 (the ID#)

Throttle up or press any command button

To operate a Command-equipped locomotive, press ENG and its ID# on CAB-1. Turn the throttle or press any command button; Railsounds II starts up (equipped locomotives) and the engine is ready to begin operations.

## Sending basic commands to locomotives with CAB-1

Accompanying sound effects are in bold italic. Some locomotives may not have all listed features.

Y

Press AUX2 to turn the locomotive's headlight on and off.

R

Press COUPLER R to open your locomotive's rear coil coupler (equipped locomotives). **Coupler release sound.**

F

Press COUPLER F to open your locomotive's front coil coupler (equipped locomotives). **Coupler release sound.**

Turn the THROTTLE to the right to accelerate, to the left to decelerate. There is no "stop." If you don't press a button or turn the throttle for a short period of time, CAB-1 "falls asleep." Press any button to "wake" CAB-1.

Press HALT for emergency stops only. HALT stops all Command-equipped locomotives in action and shuts down all PowerMaster output.



Press WSTL/HRN to activate the locomotive's horn or whistle, release to discontinue. **Steam whistle or diesel horn sound.**

Press BELL to activate the bell, again to discontinue. **Steam bell or diesel mechanical bell sound.**

In command control, DIR operates differently than in conventional Lionel operations. Press DIR—the locomotive decelerates to complete stop; turn the throttle up, and the locomotive will accelerate in the new, opposite direction. **THERE IS NO NEUTRAL. Steam or diesel letoff sound.**

Press and hold BOOST for extra power. Release BOOST and your locomotive returns to its previous speed. **Labored chuff sound.**

Press and hold BRAKE when you want to slow down or stop. Release BRAKE and your locomotive re-returns to its previous speed. Great for young children to use with Big Red. **Squealing brake sounds. Coasting chuff sounds.**



## Tuning your locomotive's performance

### SETTING MOMENTUM

TrainMaster Command's momentum feature simulates the labored performance of a real-life locomotive pulling a heavy load. Press L, M, or H (located under CAB-1's removable panel) for light, medium, or heavy momentum. The locomotive remembers this setting until you change it. For normal (quick) locomotive response, press L.

Get a feel for the difference in momentum settings. Select L, M, or H. Turn your throttle slightly and wait a few seconds for the locomotive to respond.



### SETTING STALL

Make your locomotive feel more responsive with stall. Get your locomotive moving and press SET; the locomotive will stop. Turn the throttle clockwise to get the engine moving, then decrease speed until the locomotive *just stops*. Press SET again. *Even if your locomotive doesn't move after turning the throttle, just press SET again. Stall will be set.* Your locomotive remembers the stall setting until you change it. To clear stall, press SET twice, holding it for one second each time.

#### Detail

**STALL EXPLAINED.** Set a Command-equipped locomotive's stall, and it skips from zero power to stall when you turn the throttle. Stall eliminates unnecessary throttle rotation—making your locomotive more responsive.

## Sending numeric commands to locomotives

When you address a locomotive and press AUX1, you create 10 numeric command buttons. The numeric keypad issues commands until you press any top-row button (SW, ACC, RTE, TR, or ENG). The CAB-1 keypad over-

### AUX1



lays included with your locomotives identify the numeric commands specific to each Lionel Command-equipped steam or diesel locomotive. ***Accompanying sound effects are in bold italic.***

**0** Halts and resets a locomotive. Resets direction to FORWARD or the control switch's direction setting. Resets diesel Railsounds II to automatic RPMs. ***Blows whistle or horn. RPMs return to automatic.***

**1** Raises the volume in Railsound II-equipped locomotives. ***Sound volume increases.***

**2** Reserved for future use.

**3** Raises the RPM level in Railsounds II-equipped diesel locomotives. Starts up Railsounds II in any currently addressed locomotive. ***RPMs increase. Steam blowoff. Startup sequence commences.***

**4** Lowers the volume in Railsounds II-equipped locomotives. ***Sound volume decreases.***

**5** Activates shutdown sound in Railsounds II-equipped locomotives. ***Diesel RPMs must be at idle for shutdown to occur.*** Horn/whistle, bell, and RPMs will not sound until you restart

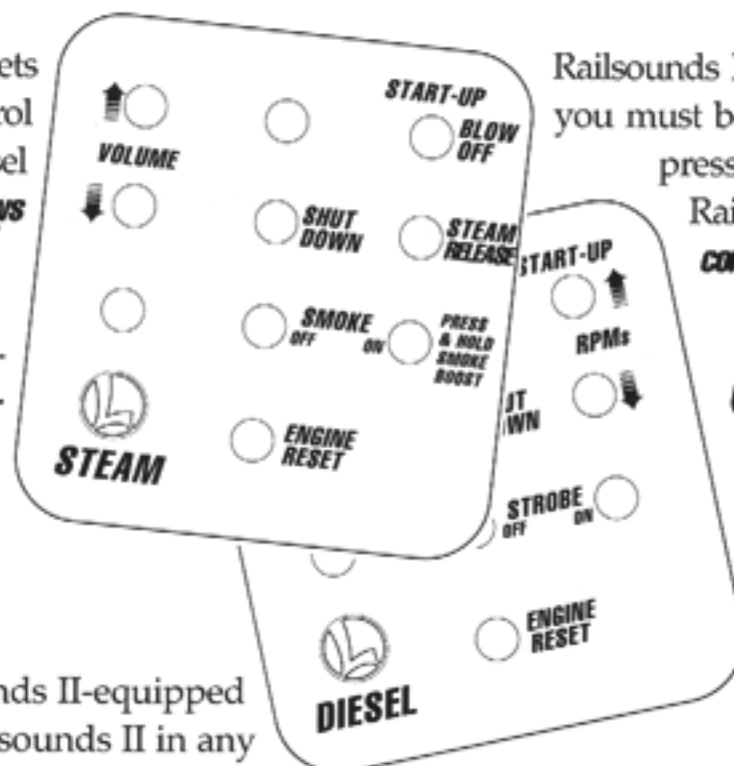

Railsounds II by pressing 3. Just like a real engine, you must be at idle (either automatic RPMs or by pressing 6) before 5 will shut down Railsounds II. ***Steam or diesel shutdown sequence commences.***

**6** Lowers the RPM level in Railsounds II-equipped diesels. ***RPMs decrease. Steam letoff.***

**7** Reserved for future use.

**8** Deactivates auxiliary lighting (diesels) and smoke unit/firebox glow (steam locomotives).

**9** Activates auxiliary lighting (diesels) and smoke unit/firebox glow (steam locomotives). Press and hold for Smoke Boost.

**AUX2** Turns headlights on and off.

# Switches

## Controlling your railroad's switches with SC-1



SC-1 is a digital terminal that mounts under your railroad and controls four switches and two accessories. With SC-1, you can throw switches to "through" (straight) or "out" (curved) positions *and* activate many Lionel operating accessories, all from the keypad of CAB-1.

## Connecting switches to SC-1



Connecting to SC-1. Middle-row terminals connect to common (ground) switch binding posts. Through and out connections connect to the upper and lower rows (respectively).

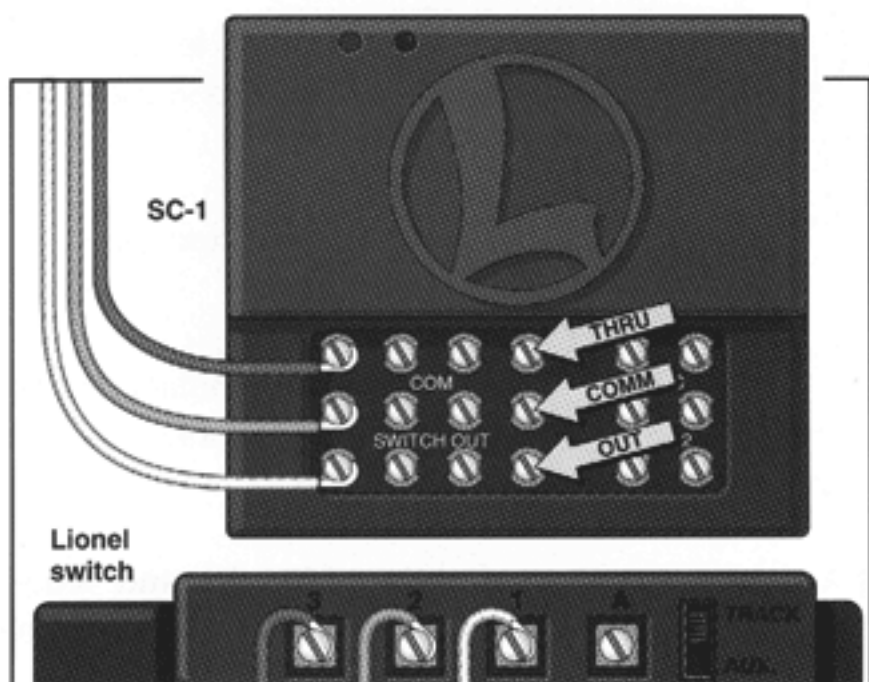

SC-1 ground (common) connections to popular Lionel switches. If your switch throws in the opposite direction, reverse the upper and lower terminal connections either on SC-1 or the switch itself.

Power *all* switches through their fixed voltage terminals. Use the adhesive number labels included with SC-1 to mark switch connection terminals. Number your switches sequentially: 1, 2, 3, 4, and so on.

Connect switch wires to the three SC-1 terminals. Begin with the ground (common) for each switch; listed below are ground terminal locations for some popular Lionel switches. Connect the ground to the center row of screws on SC-1:

- on contemporary LTI O gauge switches (nos. 3010 and 3011), ground is the center terminal;
- on postwar O22 and MPC/early LTI O gauge switches (nos. 5132 and 5133), ground is the center binding post;
- on Super O switches (where two posts are together and one post is positioned on the side) ground is the side post.

Because SC-1's ground/common terminals are connected internally, you only need to connect one ground wire between any of the four switches and SC-1.

### Hint

FINDING THE RIGHT POST. If you're in doubt about which binding post connects to the outside (ground) rail, check it with a meter or continuity tester, available from electronics supply stores.

When connecting upper and lower terminal wires, make sure the wire throwing the switch "out" (curved) connects to SC-1's "out" terminal and the wire throwing "through" (straight) connects to SC-1's "through" terminal. Check by touching each wire to its ground terminal to activate the switch throw. SC-1's green light illuminates when switches are powered.

### Hint

SC-1 INSTALLATION. To make wiring easy, install SC-1 under your railroad in a central location between the switches and accessories you wish to control. An alternative is to group SC-1s together, "control panel"-style.

## Programming SC-1 switch numbers

### **Example** *program switch numbers 1, 2, 3, and 4*

**Command Base ON**

**Switch power ON**

**SC-1 green light illuminated**

**Slide SC-1 PGM/RUN switch to PGM**



**Press SW**



**Press 1**



**Press SET**

**SC-1 red light illuminates for two seconds**

**You have assigned an ID#—1—to the first switch connected to SC-1. SC-1 programs the next three switch ID#s (2, 3, and 4) automatically**

**Slide your SC-1 PGM/RUN switch to RUN**

**Repeat these steps for other installed SC-1s**

**Note!** The next SC-1 you program will be Switch #5 or higher

Every switch needs an ID#. Now that you've labeled SC-1 switch terminals and connected the wires between switches and SC-1s, you're ready to program switch ID#s.

SC-1 works this way: you program one number—the switch connected to the first SC-1 output—and SC-1 programs the other three automatically. Follow the steps in the Example

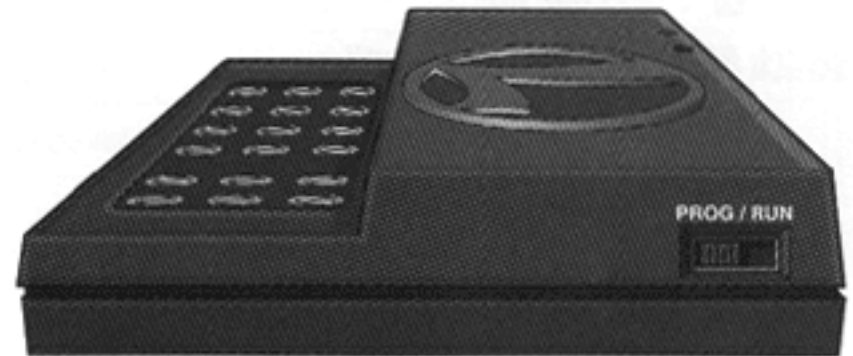

*Slide SC-1's PROGRAM/RUN switch to PROGRAM. Using CAB-1, press SW, 1 on the numeric keypad, and SET under the removable panel. Slide the switch back to RUN. You're done.*

box for each SC-1 you need to program. If you begin with Switch #1, then the next three switch ID#s (2, 3, and 4) are automatic. Your next SC-1 to be programmed will begin with Switch #5.

**Note!** Choose switch numbers between 0 and 99 (100 switches total).



# Switches

## Controlling switches with CAB-1

### Example *throw Switch #1 to "out"*



Press SW



Press 1



Press OUT

Switch #1 is now curved or "out"

### Example *throw Switch #12 to "through"*



Press SW



Press 12



Press THROUGH

Switch #12 is now straight or "through"

Now that you've programmed switch numbers, you can throw any SC-1-controlled switch using CAB-1.

#### Hint

**SWITCH SHORTHAND.** After addressing a "switch", you can immediately address another switch simply by entering its ID#—you don't have to press SW again. This is so until you press another address button (ACC, RTE, TR, or ENG).

## Notes on AUX1 and AUX2 definitions

As you'll notice in these sections on switch and accessory control, the AUX1 and AUX2 buttons on CAB-1 gain new meaning. For switches, they are defined as "through" and "out," respectively. When it comes to accessories, they have even more (and different) meanings. And as you learned in the sections on locomotive control, AUX1 and AUX2 also have other prominent meaning.

AUX1 and AUX2 are *multi-definition buttons*. Their definitions depend on which top-row address button you choose.

For example, press SW and AUX1/AUX2 control the direc-

tion of switches. Press ENG or TR and AUX1 "opens" the numeric keypad to locomotive feature control, while AUX2 controls headlight illumination. Finally, when you press ACC, the buttons change meaning again, this time to control accessory functions.







As you get comfortable with "jumping" between locomotives, switches, accessories, routes, and multi-locomotive lash-ups ("trains"), you'll acquire a feel for the many definitions of AUX1 and AUX2. Until then, just remember our basic CAB-1 rule: AUX1 and AUX2 functions always depend on which top-row address button you've just pressed.

# Creating routes around your railroad







**Example** assign Switches #2 (through), #4 (out), and #14 (through) to Route #1

**Command Base ON**







**SC-1s ON**

-  Establish the route: press RTE
-  Press 1 (the route number)
-  Begin programming: press RTE
-  Press 1 (route number)
-  Press 2 (the switch number)
-  Press THROUGH
-  Press SET

SC-1's red light illuminates for two seconds  
Switch #2 is in the "through" direction on Route #1

-  Establish the route: press RTE
-  Press 1
-  Begin programming: press RTE
-  Press 1
-  Press 4 (the switch number)
-  Press OUT
-  Press SET

SC-1's red light illuminates for two seconds  
Switch #4 is in the "out" direction on Route #1

-  Establish the route: press RTE
-  Press 1
-  Begin programming: press RTE
-  Press 1
-  Press 14 (the switch number)
-  Press THROUGH
-  Press SET

SC-1's red light illuminates for two seconds  
Switch #14 is in the "through" direction on Route #1

Every model railroad has switches, and those switches provide plenty of operational variety, especially when thrown in certain patterns—a route.

Here's a common scenario: to travel from the main line to the yard, you have a preset route: Switch #2 is through (straight), Switch #4 is out (curved), and Switch #14 is through. With TrainMaster Command, you can throw all those switches with a single command—RTE.

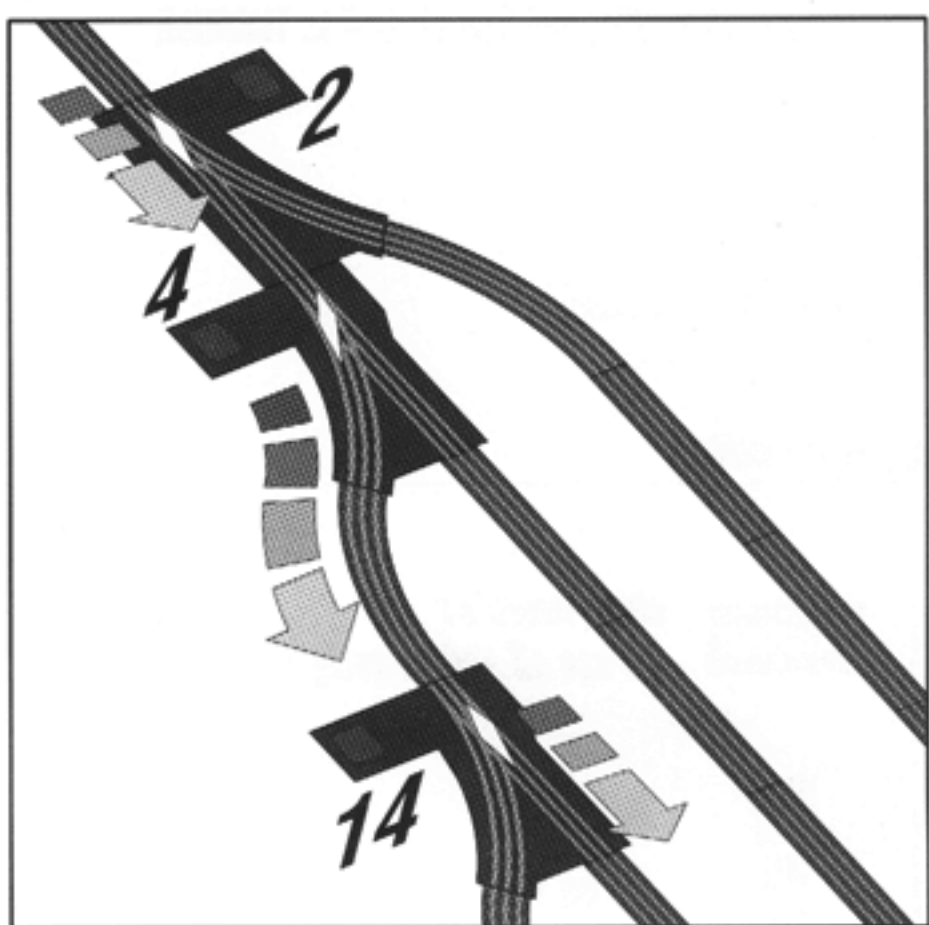

**SWITCHES AND ROUTES.** Any switch can be part of any route. And any switch can be on any number of routes, creating a wealth of possibilities. Experiment. Discover new pathways around your railroad with RTE. Routes are remembered forever—or until you clear them.

**Detail**

**Always check your RTE programming: throw switches opposite the RTE direction, then press RTE and the ID#; your route should immediately throw**

**You can add more switches to a route at any time**

# Switches

## Activating routes

---

### **Example** *activate Route #1*



Press RTE



Press 1 for one full second

**Route #1 has been selected: Switch #2 is THROUGH, Switch #4 is OUT, and Switch #14 is THROUGH**

Select any route you've programmed by pressing RTE and your chosen RTE ID#. Make sure you press and hold the ID# button for one full second. This ensures the command is issued to every SC-1 on your railroad.

### **Detail**

**"PRESS AND HOLD" DEFINED.** When you are pressing the ID# button, some of the switches may not actually throw until you've released the button. Switches activate at different times once you've selected the route—this keeps your system (and your railroad's power supplies) from overloading due to simultaneous activation.

## Clearing routes

---

### **Example** *clear Route #1 (erase all switch assignments)*



Press RTE



Press 1



Press SET

**Route #1 is now ready for new switch assignments**

**You cannot remove an individual switch from a RTE; you must clear the entire route and start again**

**If you make an error during RTE programming, do not press SET; start over—press RTE, the switch number, its position, and *then* press SET**



# Accessories

## Connecting accessories to SC-1



SC-1's accessory connections. The top row is for press-and-hold functions like loaders; bottom-row connections are for on-offs like floodlight towers. Use an SC-1 wallpack (no. AC160-1250) if your SC-1s controls accessories **ONLY**.

Most Lionel accessories can be controlled by an SC-1. Start by sequentially numbering the accessory terminals with the adhesive labels (included): 1, 2, and so on. Lower SC-1 accessory terminals are for on/off functions like light towers; they're controlled by CAB-1's AUX2 button. Upper SC-1 accessory terminals are for momentary functions like loaders and action motors; they're controlled by AUX1.

### Note!

Please refer to the TrainMaster Command SC-1 Manual for complete instructions on connecting Lionel operating accessories to SC-1.

**WARNING:** It is *extremely* important you make proper wiring connections between accessories and SC-1. Certain incorrect electrical connections can damage SC-1. The reason: SC-1 controls the flow of electricity from the ground—not hot—lead of the accessory. Connecting an accessory's "hot" lead to SC-1 will damage the component.

**WARNING:** Accessories must be externally powered; do not power them from track voltage. If an SC-1 serves only as an accessory activator (no switches are connected to it), you need to power it with a Lionel wallpack (no. AC160-1250). When properly powered, SC-1's green light will illuminate.

### Note!

Do not connect UCS and RCS uncoupling and remote-control sections to SC-1; use original-equipment controllers to activate them

### Note!

DO NOT connect accessories to track ground.

Operating accessories can be powered by PowerMasters. This gives you keypad control over their voltage levels. See page 17 for more information.

### Example

wiring a typical Lionel accessory (nos. 30/38/138 water tower) to SC-1

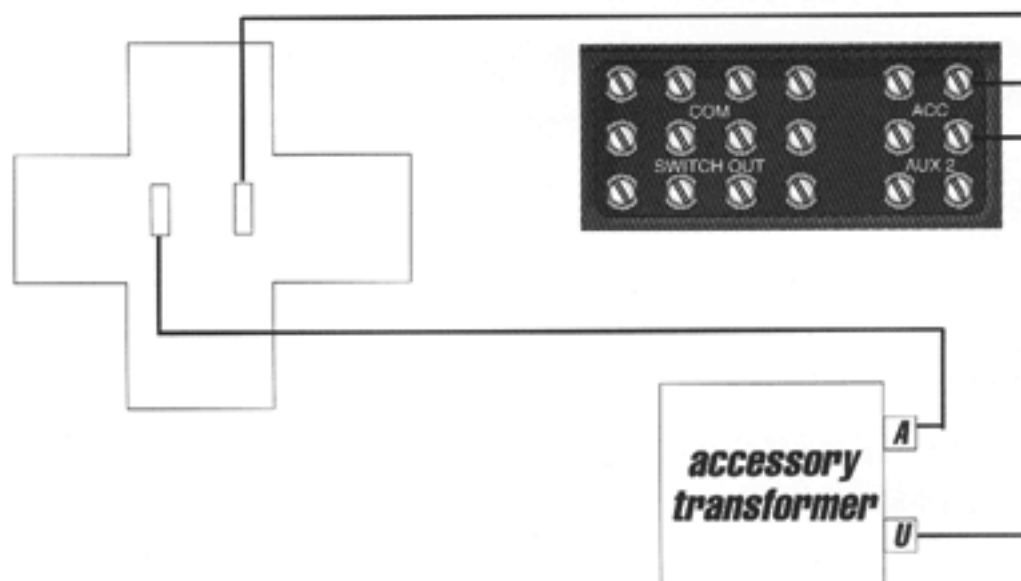

# Accessories

## Programming SC-1 accessory numbers

### **Example** *program accessory numbers 1 and 2*

**Command Base ON**

**Switch/turnout power ON or SC-1 wallpack plugged in SC-1s ON**

**Slide SC-1 PGM/RUN switch to PGM**



**Press ACC**



**Press 1**



**Press SET**

**SC-1's red light illuminates for two seconds**

**You have assigned an ID#—1—to the accessory connected to SC-1; SC-1 automatically programs the next ID# (2)**

**Slide your SC-1 PGM/RUN switch to RUN; repeat these steps for other SC-1s installed on your railroad**

**Note!**

**Program your next SC-1 accessory with an ID# of 3 or higher**

Just like switches, every accessory needs an ID#. After you've connected the wires from your accessories to SC-1s, you're ready to program.

Accessory ID#s on SC-1s are consecutive. Programming your SC-1 with "Accessory #1" will also automatically program the second connected accessory as "Accessory #2." Choose accessory ID#s between 0 and 99 (100 accessories total).

**Note!**

**ACCESSORY INCOMPATIBILITY.** Certain multi-function Lionel accessories (like magnet and intermodal cranes) cannot be controlled by SC-1 because they are internally wired to track ground. Use original-equipment controllers to activate them.

**Note!**

**SC-1 MEMORY.** SC-1 remembers the on/off status of accessories after layout power has been turned off.

## Controlling accessories with CAB-1

### **Example** *turn on Accessory #1 (floodlight tower)*



**Press ACC**



**Press 1**



**Press AUX2**

**Accessory #1's lights illuminate; press AUX 2 again to extinguish the lights**

**Example**

***activate Accessory #3 (diesel fueling station)***



**Press ACC**



**Press 3**



**Press and hold AUX1 until desired action is accomplished, then release AUX1**



**Press AUX2 to illuminate the fuel office**



**Press AUX2 again to extinguish the light**

# PowerMaster and command control

## Controlling track power with PowerMaster

### **Example** *power down Track #1*

**Command Base ON**

**PowerMasters set to CMD**

**PowerMasters ON**



Press TR



Press 1



Press AUX1



Press 0

**Track #1 is now powered down**



Press BOOST to power up Track #1

### **Example** *power down all tracks simultaneously for an emergency stop*



Press HALT

**All tracks served by PowerMasters are deactivated; reactivate them by addressing each TRACK (TR and ID#) and pressing BOOST**

On a conventional TrainMaster railroad, PowerMaster raises and lowers track power when you turn CAB-1's throttle. With TrainMaster Command, use PowerMaster the same way to help you place locomotives on track, fix derailments with remote power-downs, isolate layout divisions, set maximum power levels, and more—all from CAB-1.

## Controlling accessories with PowerMaster

Just as you can control the application of voltage to sections of your railroad with PowerMaster, you can do the same for operating accessories. Just connect the outputs from the PowerMaster to a terminal strip supplying electricity to your accessories. Then, program your PowerMaster with an "accessory-specific" ID#, and you now have keypad control of voltage to those accessories. It's just one more way to control your entire railroad from the keypad of CAB-1.



# PowerMaster and command control

## Limiting PowerMaster's output in PowerHouse installations

**Example** *set a maximum voltage level for PH-PM installations*

**Command Base ON**

**PowerMasters set to CONV**

**PowerMasters ON**



**Press TR**



**Press 1**

**Throttle up to maximum desired speed**

**Track #1 now has a maximum voltage setting**

**To restore full voltage range to Track #1:**



**Press TR**



**Press 1**

**Turn throttle to maximum voltage setting**

**OR**

**Set Track #1's PowerMaster CMD/CONV to CMD**

**Track #1 now has full voltage range restored**

If you operate trains with kids or just want to restrict the top-end speed of the locomotives in operation, you can limit the maximum voltage on your railroad. If you're using a traditional power source like the classic Lionel ZW transformer, simply reduce its output. If you're using PowerHouses to energize your railroad's PowerMasters, this Example shows you how to reduce their output.

**POWERMASTER AND SPEED CONTROL.** When you use PowerMasters to control power distribution on your railroad, you can reduce their output (and thereby set new, lower maximum voltages) by turning the throttle on CAB-1. See the accompanying Example. Reducing PowerMaster output does not affect locomotive control at slower speeds. *Note:* PowerMaster does not retain reduced voltage settings after layout shutdown.

### Detail

**ZW AND SPEED CONTROL.** If you're using variable-output power supplies like the Lionel ZW transformer to electrify PowerMaster, you can back off the ZW's output and experience a smaller overall range of output—and finer speed control throughout that range.

### Detail

**ZW DIRECT-POWER AND SPEED CONTROL.** If you're using Lionel ZWs to *directly* power your railroad (there are no PowerMasters installed on your railroad), back off ZW output to set a new maximum voltage. As a side effect, you'll realize more precise locomotive control at slower speeds.

### Detail

**SWITCH SETTINGS.** The CMD/CONV switch on PowerMaster lets you choose from two different track voltage outputs: full with CMD, or variable with CONV. The switch's setting has no effect on communications from the Command Base.

### Detail

# Power sources

## Choosing the right power source

Every model railroad needs power. And the choice is up to you. Check out the benefits of each power source option and decide which one is right for your railroad.

### ***The classic Lionel ZW transformer***

Start with the historic standard for maximum power—the Lionel ZW transformer. Use one output only for maximum ZW amperage on your chosen block. Set ZW output to full for normal operations. Back off the ZW's output level to trim maximum speeds when children are running trains. When maximum speeds are trimmed, you'll experience finer slow-speed control from your Command-equipped Lionels.



### ***The ZW-PowerMaster combination***

Combine the power of the ZW with the remote-control features of PowerMaster. For normal operations, set the ZW's output to full and slide PM-1's CMD/CONV switch to CMD. The ZW-PM-1 combination lets you enjoy all the benefits of a ZW power source as well as extra PM-1 features like remote-control circuit breaker resets and walkaround control of conventional locomotives.



### ***The PowerHouse-PowerMaster team***

For remote-control over power *and* the security of high power in a contemporary, UL-listed package, choose the PowerHouse-PowerMaster team. Get big, 8-amp power from PowerHouse. And control every electrical block and division on your railroad from the keypad of CAB-1.

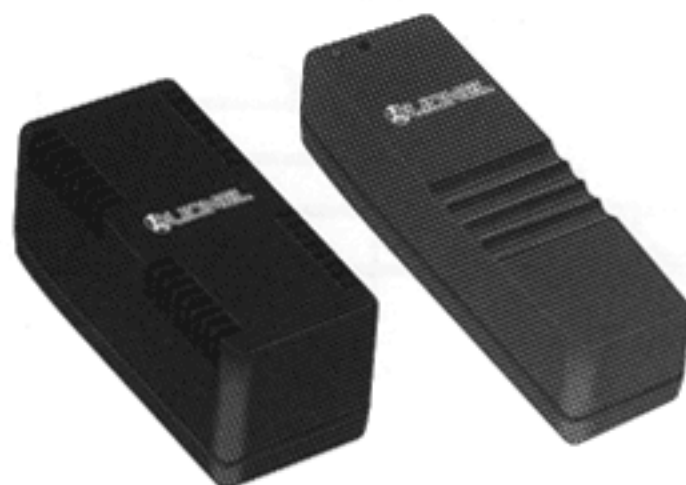

# Powering your railroad

## Solutions for a power-hungry railroad

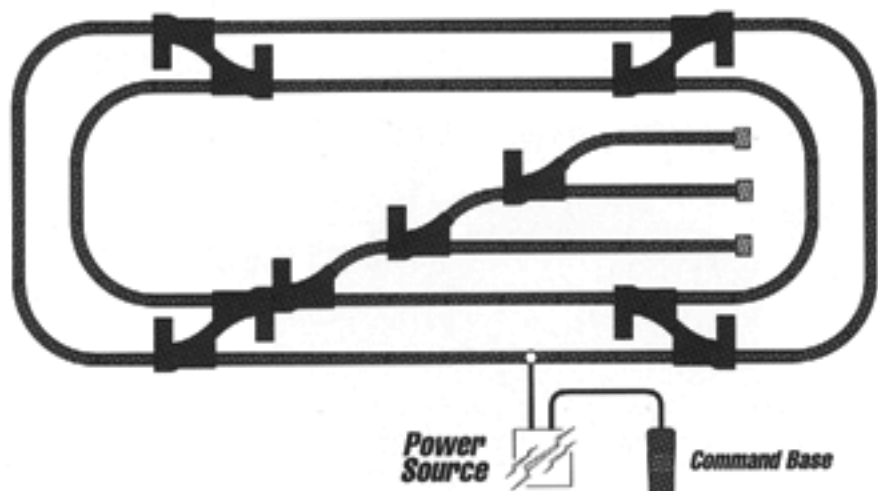

Here's a basic TrainMaster Command layout: two concentric loops linked by Lionel switches, with a small yard in the middle. If you're running only one or two locomotives at a time, this track plan will require only a single transformer for adequate power.

And you only need one Command Base per layout.

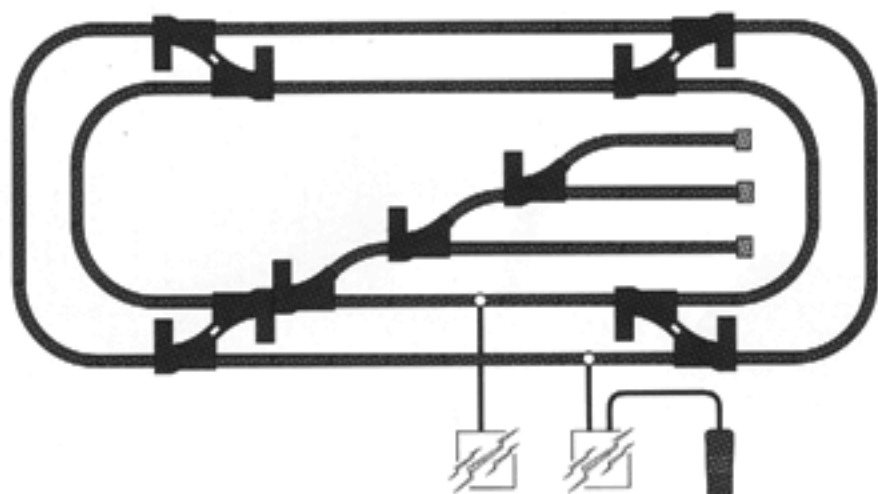

Now, install another power source, and you instantly divide your railroad's amperage load between two *blocks*. When you create blocks of electrical distribution, you can power *more* Command-equipped locomotives at once. Keep the size of the blocks small, and your Command-equipped Lionels will have all the power they need.

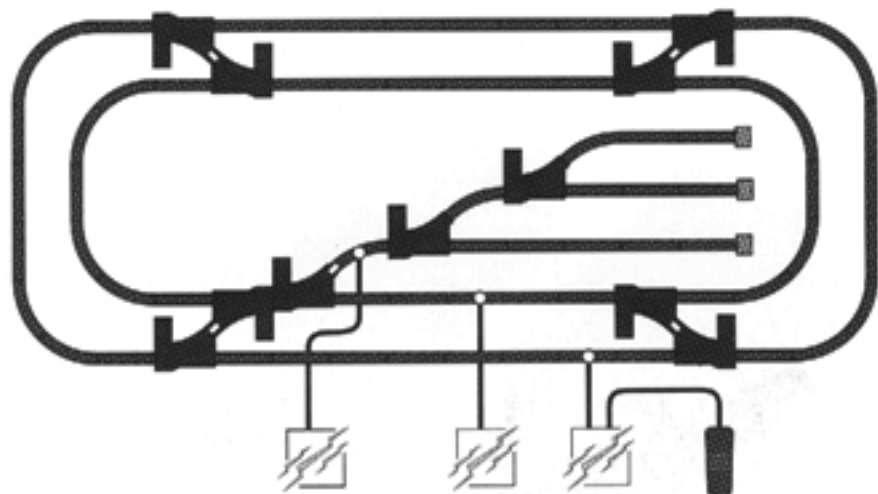

Here's a three power-source example. With each layout sector individually and substantially powered, your railroad will always be ready for whatever Lionel action you can envision: single operation, multi-unit lash-ups, and more.

Imagine a gigantic layout, eighty feet in length. You *could* run it with a single power supply, but then, this is an 80-foot-long, dogbone-style model railroad—like the ones used by popular Lionel modular operating clubs. Long trains, multi-locomotive lash-ups, and more—all courtesy of TrainMaster Command—can put a heavy load on your power source.

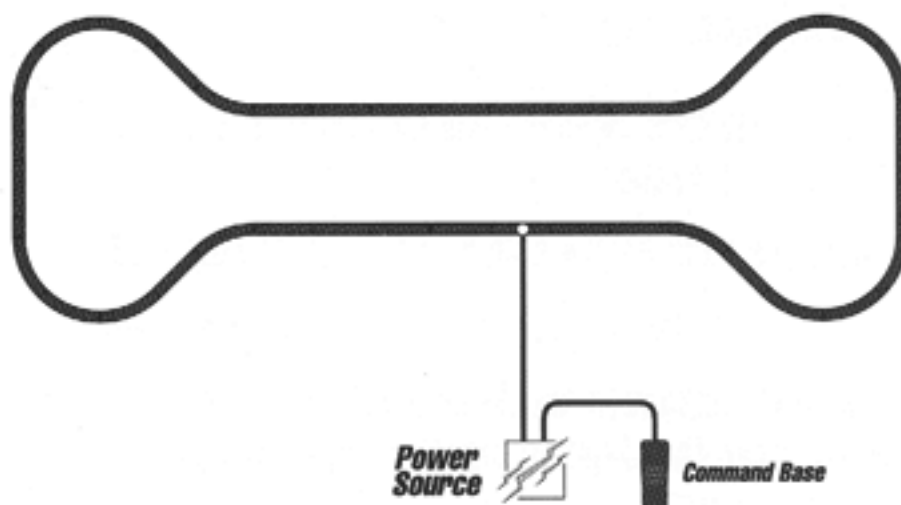

Multi-locomotive operation will cause a single power source to reach its limit quickly. Add electrically isolated blocks powered by healthy power sources, and your amperage worries are over.

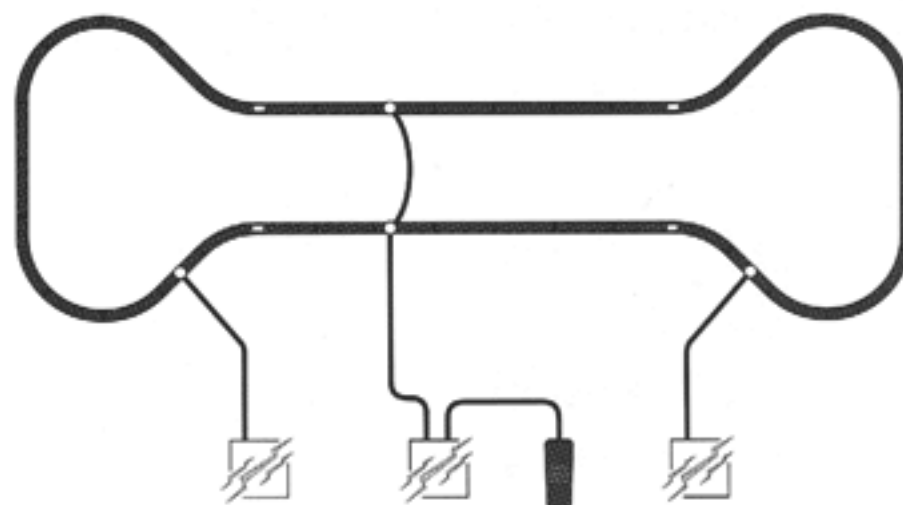

And with PowerMasters, you not only enjoy CAB-1 remote-control over your railroad's power distribution—you can group those individual PM-1s into *divisions* that grid your railroad. For example, for "Division 1," group the three power sources by assigning all PM-1 ID#s "TRACK 1." After manual power-downs, short-circuits from derailments, or amperage overloads, simply press TR, 1, and BOOST, and your *entire* railroad is back on line. From anywhere.

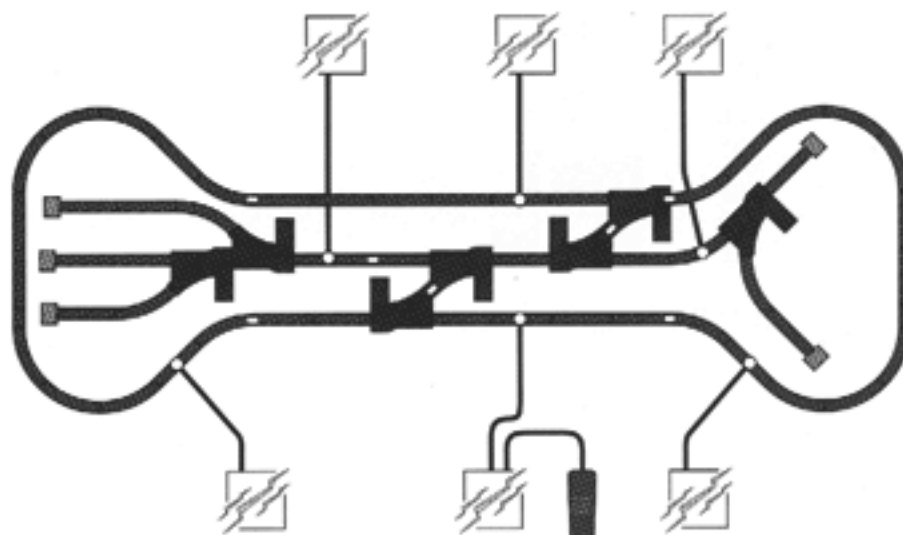

Add track and Command-equipped locomotives, and this giant of a model railroad needs *two* divisions. Just remember the formula: small blocks fed by healthy power sources. Your Command-equipped Lionels will give you superior performance when they have a dependable supply of power.



# Advanced operating techniques

## Building lash-ups

**Example** build Train #7 with Engines #13, #5, and #84





All locomotives' reverse unit control switches set to FORWARD

Address each engine individually with its engine ID

Move each engine into position; do not couple them





"Front" locomotive should be positioned in the forward direction (headlight in front); middle and rear locomotives can face in either direction

In Train #7, assign the lash-up's front engine (Engine #13) using the F (Front) button:

	Press TR
	Press 7
	Press 13
	Press F
	Press SET

Hear the horn/whistle blow

Assign the lash-up's middle engine (Engine #5):

	Press TR
	Press 7
	Press 5
	Press SET

Hear the horn/whistle blow

(continued on page 23)

When real railroads operate two, three, or even four locomotives together, they call it a "lash-up." A lash-up is railroading's answer to steep grades, long trains, and extra-heavy loads.

In the TrainMaster Command system, lash-ups are addressed as "TRAINS"—the TR button on CAB-1. When you build lash-ups with TrainMaster Command, several engines are grouped under a single TR ID#. *Lash-up building should be attempted only after you've mastered ordinary TrainMaster Command operations.*

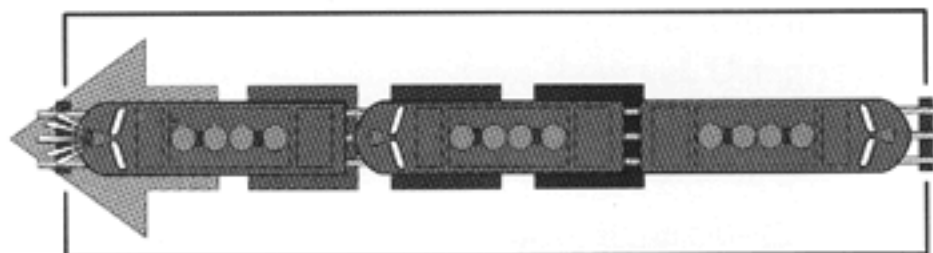

Pick the locomotives in your lash-up and move them together (but don't couple them) using ENG and each one's ID#. Because CAB-1's TR button also means "TRACK" for PowerMaster control, select a TRAIN (TR) ID# that is NOT a number identifying PowerMaster TRACKS. For example, if you're using four PowerMasters and have named their TRACKS 1, 2, 3, and 4, choose a number between 5 and 9 for your TRAIN ID#.

Finally, make certain the locomotive's direction switch is on FORWARD/RUN. Perform a locomotive reset (AUX1, 0) to see what the locomotive's first-start direction is. It's possible to have a "contrary" locomotive that's simply following the direction of the reverse unit control switch.

### Note!

"WRONG" ENTRIES. If you press a wrong button while building a lash-up, start over with that particular locomotive assignment at the TR command; the assignment isn't sent until you press SET.

**Note!**

If any engine in the lash-up faces backwards, press DIR before SET



Assign the lash-up's rear locomotive (Engine #84 facing backwards) using the R (Rear) button and DIR button:

-  Press TR
-  Press 7
-  Press 84
-  Press R
-  Press DIR
-  Press SET

Hear the horn/whistle blow

Couple the locomotives by addressing them as ENGINES

Reset the direction of the lash-up:

-  Press TR
-  Press 7
-  Press AUX1
-  Press 0

Now all engines respond together when you address them as Train #7

If an engine is out of sync after a TR reset, read "Lash-up troubleshooting" on page 26

**Note!**

IT'S STILL AN ENGINE. Whenever a locomotive is in a lash-up, you can still individually address it (using its ENG ID#) to adjust lighting, open individual couplers, and tune performance.

STROBES STILL FLASH. Diesel locomotive auxiliary lights (example: flashing warning lights/strobe lights) are independent of the lash-up's direction-specific illumination. In other words, if a lash-up rear locomotive's headlight is dark, the strobe still flashes until extinguished by pressing 8 on the numeric keypad.

**Note!**

LOCOMOTIVE CABS FACE "OUT." When operating strobe-equipped locomotives, make sure you build your lash-ups with locomotive cabs facing outward—that is, not facing each other on lash-up-ending units. The reason: strobe-equipped locomotives (e.g. SD60, Dash 8) do not come equipped with directional headlights. To ensure such units' headlights operate in lash-ups, position the "outside" locomotives so that their cabs face "out."

**Note!**

DITCH LIGHTS. Locomotive ditch lights (equipped engines only) operate in the locomotive's standard "forward" direction *only*.

**Note!**

# Advanced operating techniques

## Addressing lash-ups

**Example** *address Train #7*

TR

Press TR

7

Press 7 (the ID#)

Throttle up or press any command button

When first operating a lash-up, press TR and its ID# on CAB-1. Turn the throttle or press any command button; your lash-up's Railsounds II sound system starts up and the engines are ready for operation.

If you've shut down a lash-up's Railsounds II by pressing the 5 button on the numeric keypad, you can restart Railsounds II only by pressing the 3 button. See "Sending numeric commands to lash-ups" for complete information on keypad control of Railsounds II.

## Sending basic commands to lash-ups with CAB-1

*Accompanying sound effects are in bold italic.*

*Some locomotives may not have all listed features.*

**R**

Press COUPLER R to open your lash-up's rear coil coupler (equipped locomotives only). **Coupler release.**

**F**

Press COUPLER F to open your lash-up's front coil coupler (equipped locomotives only). **Coupler release.**



Turn the THROTTLE to the right to accelerate, to the left to decelerate. There is no "stop." If you don't press a button or turn the throttle for a short period of time, CAB-1 "falls asleep." Press BOOST to "wake" CAB-1. **DynaChuff speed-dependent labored or coasting chuffs.**



Press HALT for emergency stops only. HALT shuts down all PowerMaster output and stops all Command-equipped engines in action.



Press WSTL/HRN to activate the lash-up's front-engine horn or whistle, release to discontinue. **Steam whistle or diesel horn.**



Press BELL once to activate the lash-up's front locomotive bell, again to discontinue. **Steam bell or diesel mechanical bell.**



Press DIR and the lash-up decelerates to a complete stop; turn the throttle up, and the lash-up accelerates in the new, opposite direction. **THERE IS NO NEUTRAL. Steam or diesel letoff sound.**



Press and hold BOOST for extra power. Release BOOST and your lash-up returns to its previous speed. BOOST wakes up CAB-1. **DynaChuff labored chuffing.**



Press and hold BRAKE to slow down or stop. Release BRAKE and your lash-up returns to its previous speed. **Squealing brake sound. DynaChuff coasting chuffs.**



## Sending numeric commands to lash-ups

When you press AUX1, you create 10 numeric command buttons. The keypad stays "open" until you press any



address button (SW, ACC, RTE, TR, or ENG). **Accompanying sound effects are in bold italic.**

**0** Halts and resets a lash-up. Resets direction to reverse unit control switch setting(s). Resets Railsounds II diesels to automatic RPMs. **Blows whistle or horn. RPMs return to automatic operation.**

**1** Raises the volume in Railsound II-equipped locomotives. **Sound volume increases.**

**2** Reserved for future use.

**3** Raises the RPM level in Railsounds II-equipped diesel locomotives. Starts up Railsounds II in all lash-up locomotives. **Startup sequence commences. RPMs increase. Blowoff sounds.**

**4** Lowers the volume in Railsounds II-equipped locomotives. **Sound volume decreases.**

**5** Activates shutdown sound in Railsounds II-equipped locomotives. **Diesel RPMs must be at idle for shutdown to**

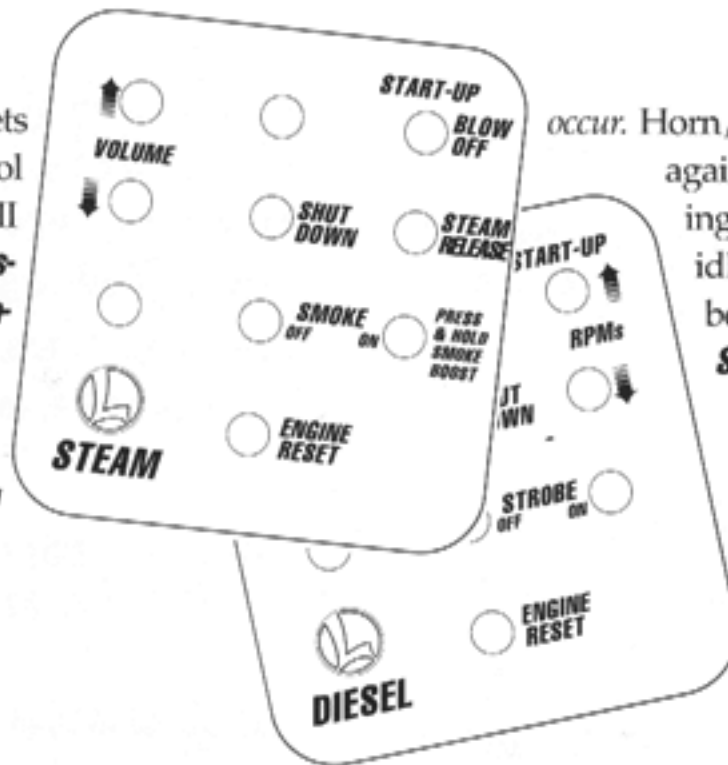

**occur.** Horn/whistle, bell, and RPMs will not sound again until you restart Railsounds II by pressing 3. Just like a real engine, you must be at idle (by automatic RPMs or by pressing 6) before 5 will shut down Railsounds II. **Steam or diesel shutdown sequence commences.**

**6** Lowers the RPM level in Railsounds II-equipped diesels. **RPMs decrease. Letoff sounds.**

**7** Reserved for future use.

**8** Deactivates auxiliary Mars lights (diesels) and smoke unit/firebox glow (steam locomotives).

**9** Activates auxiliary Mars lights (diesels) and smoke unit/firebox glow (steam locomotives).

**AUX2** Turns headlights on and off.

## Removing locomotives from lash-ups

### Example

**remove Engine #84 from its lash-up by reassigning it to Train #0**

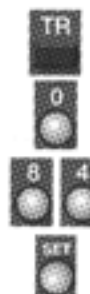

Press TR

Press 0

Press 84

Press SET

Hear the horn/whistle blow

Engine #84 is no longer part of the lash-up

You can remove any locomotive from a lash-up by assigning it to "Train #0."

Remember to remove all locomotives from a lash-up after you've physically broken up the consist.



# Advanced operating techniques

## Lash-up problemsolving

### Example

*I'm operating Train #7; one "out of sync" engine fights the others*

Reset the direction of the lash-up:



Press TR



Press 7



Press AUX1



Press 0

Hear the horn/whistle blow

This resets the lash-up; do this whenever you've finished lash-up building *or* when you first begin running a lash-up. Still trouble? Reassign the troublesome engine to the lash-up by either using *or* not using the DIR button. Do another lash-up reset and try again.

### Example

*I'm operating a lash-up that includes a number of locomotives, but the circuit breaker keeps tripping*

It's possible to operate any number of powered and unpowered locomotives in a lash-up. In reality, however, total power available on the track limits that number. PowerMaster can generally handle six motors maximum, a ZW slightly less. If the circuit breaker keeps tripping, reduce the number of powered locomotives on the track by removing them from your lash-up.

### Hint

Single-motored locomotives usually draw less power than dual-motored locomotives

# Notes on lash-ups

### Detail

LASH-UP BEHAVIOR. TrainMaster Command lash-ups act like real-life ones. Press HORN; only the lead unit's horn blows. The same is true for BELL. The lead locomotive's headlight illuminates while the others remain dark. Hit DIR and lighting reverses to that of the rear unit (equipped locomotives only). Press COUPLER F and the lash-up's front coupler will open; COUPLER R opens the lash-up's back coupler.

### Detail

PICK THE RIGHT NUMBER. The TR address button talks to PowerMaster TRACKS A N D TRAINS. Choose TRAIN ID#s with numbers different from PowerMaster ID#s. If your PowerMasters are 1, 2, and 3, select TRAIN ID#s starting with 4. If you want more TRAIN numbers, assign all PowerMasters as TRACK #1 or "group" them together so that two or more PowerMasters share the same ID#. This enables you to address groups of PowerMasters with a single ID# command.

### Detail

BE TIDY. Always clear a lash-up once you've broken it up. This reactivates functions that are "disabled" in

# Tuning lash-up performance

### Example set momentum for Train #7

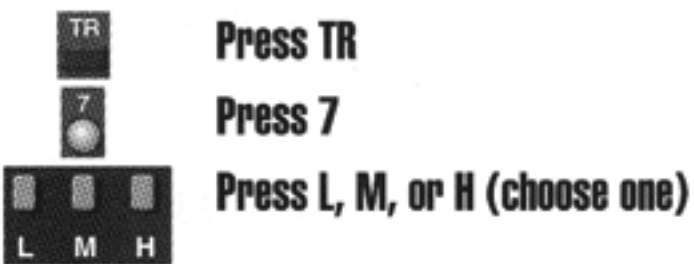

Train #7's momentum setting has been changed

### Note!

Setting TR momentum erases preexisting ENG momentum settings for all locomotives in the lash-up

### LASH-UP MOMENTUM

Press L, M, or H (located under the removable panel) for light, medium, or heavy lash-up momentum. The LCRUs remember this setting until you change it.

### LASH-UP STALL

Get your lash-up moving slowly. Press SET; the lash-up stops. Turn the throttle clockwise to get the lash-up moving, then decrease speed until the lash-up just stops. Press SET again. Stall has been set. Even if your lash-up doesn't move after turning the throttle, just press SET again. Stall will be set. The lash-up LCRUs remember this setting until you change it.

If the locomotives in your lash-up are of different types and do not all start at once (even after setting train stall), fine-tune the lash-up's performance by setting stall individually for each locomotive in the lash-up. See the section on setting locomotive stall voltage.

### Detail

WHY STALL? In command control, stall voltage gives locomotives a common "start threshold." When you run a lash-up with stall set, every locomotive will begin moving in unison. Turning the throttle down completely turns each locomotive down to its own stall setting.

# Advanced operating techniques

## Transitional command control with ZW transformers

**Command Base ON**

**ZW output variable**

**Command-equipped locomotives and one conventional locomotive per ZW-controlled track**

**Example**

*operate a conventional locomotive and Command-equipped Lionels together*

**Power down the track:**



**Power down ZW track output**

**Put the conventional locomotive on track:**



**Power up ZW track output and cycle the conventional engine's reverse unit to NEUTRAL**

**Place a Command-equipped Lionel on track but don't address it**

**Get your conventional locomotive into action:**



**Power up ZW track output**

**Choose an optimum track voltage for both your conventional engine and Command-equipped Lionel**

**Get your Command-equipped Lionel into action:**



**Press ENG**



**Press 55 (its ID#)**



**Press BOOST**

**Throttle up Engine #55 to your desired speed**

*(continued on page 29)*

Transitional command control lets you run one conventional locomotive and Command-equipped locomotives simultaneously on the same track, using your ZW transformer *and* CAB-1.

**Note!**

*Transitional command control is for advanced TrainMaster Command operators only.*

Choose your conventional locomotive. With ZW track output OFF, place the conventional engine on track. Power up (12 volts minimum) and cycle its reverse unit to NEUTRAL.

Next, choose your Command-equipped locomotive(s). Place them on track, but don't address them yet. Using your ZW's power handle *or* DIRECTION button, cycle the conventional locomotive's reverse unit to forward or neutral (your choice) and set it into motion.

Now, address your Command-equipped locomotive(s) by pressing ENG and the ID#(s) on CAB-1. Power up the engine(s) and run them *around* your conventional locomotive. Control your conventional engine by raising and lowering track voltage from your ZW. Control your Command-equipped Lionels with CAB-1.

**VARIABLE VOLTAGE LIMITATIONS.** Because you're using variable voltage, both the top speed *and* overall speed range of your Command-equipped Lionels are dependent on the track voltage you're applying in order to control your conventional locomotive.

**Note!**

**COIL COUPLERS.** Command-activated coil couplers may not perform reliably when operating in transitional command control. Raise track voltage if your coil couplers do not respond.

**Note!**

**Adjust your conventional engine's speed:**



**Reduce ZW output**

**Blow your conventional locomotive's horn using the ZW whistle/horn button**

**Blow your Command-equipped Lionel's horn using the WSTL/HRN button on CAB-1**



**Press WSTL/HRN**

**Increase your conventional locomotive's speed:**



**Increase ZW output**

**Add more Command-equipped locomotives to the action: Press ENG, their ID numbers, and throttle them up to the desired speed**

**Want to change conventional locomotives? Power down ZW track voltage; all locomotives will stop. Replace the conventional engine, increase track power, and get the conventional locomotive into action. Readdress your Command-equipped engines with ENG and their ID#s, then throttle them up using CAB-1.**

**Note!**

**Total locomotives in operation depend on the locomotives' amperage draw and the amount of track your ZW electrifies**

**Detail**

**TCC DEFINED.** Transitional command control: the nonCommand-equipped locomotive behaves in the old Lionel tradition, responding to your adjustments in track power. Your Command-equipped locomotives still receive their digital signalling from the Command Base, and operate in the same, independent manner as when receiving a continuous 18 volts. However, the maximum speed of the Command-equipped locomotives is dependent on the amount of voltage you're applying to the track at the time. Also, if your conventional locomotive is moving slowly, introducing a Command-equipped locomotive will further slow your conventional locomotive. Experiment. Explore transitional command control.



# Advanced operating techniques

## Transitional command control with PowerMasters

**Command Base ON**

**PowerMasters set to CONV**

**PowerHouse ON/ZW ON FULL and PowerMasters ON**

**Command-equipped locomotives and one conventional locomotive per PowerMaster**

**Example** *place a conventional locomotive on Track #1*

**If the track is powered up:**



**Press TR**



**Press 1**



**Press AUX1**



**Press 0**

**Put the conventional locomotive on Track #1**

**Restore track power by pressing BOOST; use DIR to place the conventional locomotive in neutral**

**Example** *address Command-equipped Engine #1*

**Throttle up Track #1 to full power**



**Press ENG**



**Press 1**

**You now have complete control of Engine #1**

*(continued on page 29)*

Transitional command control with a traditional transformer is fun—but TCC with remote-control of track power is even better! PowerMaster-based transitional command control lets you and your friends and family control every locomotive you own—Command-equipped and conventional—from anywhere around your railroad using CAB-1.

### Note!

*Transitional command control is for advanced TrainMaster Command operators only.*

Turn on the Command Base and set all PowerMaster CMD/CONV switches to CONV (conventional) for the divisions on which you'll operate conventional locomotives *only*. Leave all Command-only PowerMaster divisions on CMD. To operate a conventional locomotive on all PowerMaster divisions, set all CMD/ CONV switches to CONV.

Power down Track #1. Place the conventional locomotive on Track #1; put it in neutral. Increase track power with CAB-1's throttle. Address Command-equipped Engine #1 and throttle it up. Your conventional locomotive stands by. After bringing Command-equipped Engine #1 to a stop, use track power to run your conventional locomotive on the same track. Command-equipped Engine #1 will stand by, awaiting new orders, while your conventional locomotive runs.

### Note!

**BE CAREFUL.** When operating conventional locomotives on a railroad where some PowerMaster divisions are still set to CMD, make sure the conventional engines *do not* pass into the Command divisions. They will encounter 18 volts and run at their top end. Potential damage could occur.

### Note!

**COIL COUPLERS.** Command-activated coil couplers may not perform reliably when operating in transitional command control. Raise track voltage if your coil couplers do not respond.

**Example**

*run a conventional and Command-equipped Engine #1 on Track #1*



Press TR



Press 1

Throttle up the conventional locomotive to medium-to-high speed



Press ENG



Press 1

Throttle up Engine #1 to the desired speed

Add more Command-equipped locomotives to the action: Press ENG, their ID numbers, and throttle them up to the desired speed

**Hint**

Alternate between the conventional and Command-equipped locomotives using TR and ENG buttons



Press ENG

You control the Command-equipped locomotive



Press TR

You control the conventional locomotive

**Note!**

You can operate up to two dual-motored Command-equipped locomotives and one conventional locomotive per PowerMaster, depending on locomotive maintenance

Now, operate both kinds of locomotives at the same time. Get your conventional locomotive going at a set speed on Track #1. Then follow it around the railroad with Command-equipped Engine #1.

**Note!**

**SPEED LIMIT.** Maximum speed of *all* Command-equipped locomotives determined by the voltage placed on the track at the time.

**Detail**

**TCC DEFINED.** Transitional command control: the nonCommand-equipped locomotive behaves in the old Lionel tradition, responding to your adjustments in track power. Your Command-equipped locomotives still receive their digital signalling from the Command Base, and operate in the same, independent manner as when receiving a continuous 18 volts. However, the maximum speed of the Command-equipped locomotives is dependent on the amount of voltage you're applying to the track at the time. Also, if your conventional locomotive is moving slowly, introducing a Command-equipped locomotive will further slow your conventional locomotive. Experiment. Explore transitional command control.

**Detail**

**CMD AND CONV TOGETHER.** You can experience transitional command control (variable voltage) and TrainMaster command control (constant voltage) on the same layout. Set PowerMasters to CONV on transitional command control divisions. Set PowerMasters to CMD on divisions that will be operating command control *only*.

# Advanced operating techniques

## "Sticky" keys

### Example

*master sticky keys by operating a variety of trains and accessories*



Press ENG



Press 1

Engine #1 is ready; power it up



Press SW



Press 34



Press OUT

Switch #34 throws "out" (curved); this switch is now "stuck" in CAB-1's memory; press OUT/THROUGH any time without SW and only Switch #34 will respond



Press WSTL/HRN

Engine #1's horn sounds; *all* CAB-1 command buttons are still active for Engine #1—you don't need to press ENG or the ID# to get response



Press and hold BRAKE

Engine #1 slows and stops; release when ready to proceed



Press THROUGH

Switch #34 throws "through"; you don't need to press SW or the ID#



Press TR



Press 8

Train #8 is ready—all CAB-1 command buttons are now active for your chosen consist:



Press WSTL/HRN



Press BOOST; release when ready

Throw Switch #34 to "out":



Press SW (only press an ID# if it's different)



Press OUT

CAB-1 always remembers your last ID# for ENG, TR, SW, and ACC. Here you *must* press SW with OUT; AUX1/AUX2 were "stuck" to Train #8

(continued on page 25)

With CAB-1, total control of your TrainMaster Command railroad is in your hands. And experiencing that control is even easier when you master CAB-1's "sticky" keys.

In basic terms, "sticky" keys mean that once you've pressed a top-row button (SW, ACC, RTE, TR, or ENG) and a specific ID#, CAB-1 will control that engine, train, or accessory until you tell it to control another one. For example, press ENG and an ID#, and CAB-1 remembers that locomotive. Press the command buttons you want (HRN/WSTL, BELL, DIR, BOOST, BRAKE, COUPLER F or R, or AUX1 and AUX2) and CAB-1 "speaks" to your chosen Command-equipped locomotive. You don't need to re-enter the ID#. You don't even have to press ENG again. A locomotive, switch, or accessory "sticks" with CAB-1 until you choose another.

Sticky keys also give you the power to "jump" between control of locomotives, consists, switches, routes, and accessories without re-entering ID#s. Jump between ENGs and TRs simply by pressing the address buttons. Throw switches and routes, and your command buttons like HRN/WSTL activate the last engine or train you "spoke" to. You can even use dual-function buttons like AUX1 and AUX2 to throw switches *or* open the numeric keypad for locomotive feature control simply by hitting SW or ENG/TR first.

An ID# is "stuck" in CAB-1's memory until:

1. you enter another ID#, or
2. you change CAB-1's batteries.

Brake Train #8; TR is the locomotive "stuck" in CAB-1's memory:

 Press BRAKE

Activate Engine #1's bell; press ENG (without "1") to make Engine #1 the active locomotive for CAB-1's command buttons:

 Press ENG

 Press BELL

Activate Accessory #77:

 Press ACC

 Press 77

 Press AUX1

"Jump" to Train #8 by pressing TR and any command button:

 Press TR

 Press WSTL/HRN

Use AUX1 to open the numeric keypad for Train #8; raise RPM level:

 Press AUX1

 Press 3

Press SW to redefine AUX1 as the THROUGH switch command:

 Press SW

 Press THROUGH (throws switch #34)

"Jump" to Accessory #77 and deactivate it, again using AUX1:

 Press ACC

 Press AUX1

Bring Engine #1 to a stop:

 Press ENG

Throttle down to stall; bring Train #8 to a stop:

 Press TR

Throttle down to stall

### Detail

CAB-1 NEVER FORGETS. Once you select an ENG or TR, SW or ACC, CAB-1 retains that ID# in its memory, even when you press other top-row address keys like SW, RTE, or ACC.

### Detail

THIS SYSTEM CAN HANDLE IT. TrainMaster Command allows for the continuous operation of up to 100 locomotives. The only limitations: available power and operator capability.

### Example *throw several switches*

 Press SW

 Press ID#

  Press THROUGH/OUT

Throw another switch (don't press SW again)

 Press ID#

  Press THROUGH/OUT



# Command control on your railroad

## Recommended layout modifications

When operating Lionel TrainMaster with constant voltage, you may wish to modify certain layout features.

### TRACK BUMPERS

Replace the original bulbs with 18- or 20-volt bulbs if they burn out. Refer to the Bulb Replacement Chart.

### UNCOUPLE/UNLOAD TRACK SECTIONS

You must operate UCS/RCS uncouple/unload tracks with their original-equipment controllers—not with SC-1s. Because of the high track voltage in the TrainMaster Command operating environment, power UCS and RCS sections with an *accessory power source*. Detach the controller wire from UCS terminal 3 (terminal 4 on RCS and O-27 UCSs). Next, connect your accessory power source lead to the terminal; we recommend 12 volts AC for optimum performance.

### SWITCHES

Switches must be powered externally, using their fixed-voltage plugs and 12 volts AC or less. *Do not power them from the track.* If your layout has older switches that lack fixed-voltage plugs, use higher-voltage lamps or modify the switches for external power. Activating a switch for too long with TrainMaster Command's constant voltage may burn out the bulb and damage the lamp housing.

### PASSENGER CARS

If your passenger cars feature two bulbs that are not grounded to the frame, you can wire the bulbs in series. If they are grounded to the frame, replace the bulbs with higher-voltage bulbs. Refer to the bulb replacement chart on the next page.

### MODERN STEAM TENDERS WITH AIR WHISTLES

Lionel steam tenders with air whistles and electronic control boards manufactured by Fundimensions and LTI will blow continuously at high track voltage. Since horn/whistle commands are not sent as DC levels in command control (the form of signalling that the control boards were designed to detect), these tenders will not work correctly. We recommend you disconnect the sound unit from its power source *or* not operate the unit.

### ACCESSORIES

All accessories must be externally powered; do not power them from the track. We recommend a separate transformer that allows you to choose the optimum voltage for each accessory's operation.

### OPERATING CARS

We recommend you modify the UCS/RCS track's "unload" contact rails for separate power.

## Bulb replacement chart

<i>manufacturer</i>	<i>lamp number</i>	<i>amps</i>	<i>base</i>	<i>bulb size</i>	<i>Lionel number</i>
Tung-Sol	1445	.15	bayonet	.46" round	600-1445-300
Sylvania/GE	1447	.15	screw	.46" round	600-1447-300
	432	.25	screw	.58" round	
	433	.25	bayonet	.58" round	
	1456	.25	bayonet	.64" round	
	1457	.25	screw	.64" round	
	1458	.25	bayonet	.64" round	
	2316	.04	bi-pin	T-1 3/4	
	2102	.04	wires	T-1 3/4	

### Note

All bulbs listed above are rated for use at 18 volts. Bulbs with an accompanying Lionel number are available from Lionel Service and Authorized Lionel Service Stations.



# Base-computer communications

## Using the Command Base's serial port

Your Command Base's serial port allows you to connect the Base to your personal computer using a nine-pin D serial cable. Software is in development and should arrive in the marketplace in 1996. Here are a number of key points regarding the use of the serial port.

- Communications is at 9600 baud, one stop bit, no parity.

- The port echos all commands received from CAB-1 remotes in a three-byte format.
- The first byte is OFE, followed by two bytes corresponding to the 16-bit words of the command table.
- Commands may be sent to the Base (and your Command-equipped locomotives) from your computer in the same format as CAB-1 commands.

## General command format

### Bit order

MSB															LSB
15	14	13	12	11	10	9	8	7	6	5	4	3	2	1	0

Note: Bits transmitted/received in descending order, i.e. bit 15 first.

### Switch commands

0	1	A	A	A	A	A	A	A	C	C	D	D	D	D	D
---	---	---	---	---	---	---	---	---	---	---	---	---	---	---	---

### Route commands

1	1	0	1	A	A	A	A	A	C	C	D	D	D	D	D
---	---	---	---	---	---	---	---	---	---	---	---	---	---	---	---

### Engine commands

0	0	A	A	A	A	A	A	A	C	C	D	D	D	D	D
---	---	---	---	---	---	---	---	---	---	---	---	---	---	---	---

### Train commands

1	1	0	0	1	A	A	A	A	C	C	D	D	D	D	D
---	---	---	---	---	---	---	---	---	---	---	---	---	---	---	---

### Accessory commands

1	0	A	A	A	A	A	A	A	C	C	D	D	D	D	D
---	---	---	---	---	---	---	---	---	---	---	---	---	---	---	---

### Group commands (several accessories activated together)

1	1	0	0	0	A	A	A	A	C	C	D	D	D	D	D
---	---	---	---	---	---	---	---	---	---	---	---	---	---	---	---

### Definitions

**A**—Address field: the address for the object (switch, route, engine, etc.) receiving the command.

**C**—Command field:

00—action

01—Extended

10—Relative speed

11—Absolute speed

**D**—Data field: the data being sent to the addressed object.

## Command set

<i>Switch commands</i>	<i>Command field</i>		<i>Data field</i>				
throw THROUGH	0	0	0	0	0	0	0
throw OUT	0	0	1	1	1	1	1
set address	0	1	0	1	0	1	1
assign to route THROUGH (D=route ID#)	1	0	D	D	D	D	D
assign to route OUT (D=route ID#)	1	1	D	D	D	D	D

<i>Route commands</i>	<i>Command field</i>		<i>Data field</i>				
Route throw	0	0	1	1	1	1	1
Route clear	0	1	0	1	1	0	0

<i>Engine or Train action commands</i>	<i>Command field</i>		<i>Data field</i>				
forward direction	0	0	0	0	0	0	0
toggle Direction	0	0	0	0	0	0	1
reverse direction	0	0	0	0	0	1	1
Boost	0	0	0	0	1	0	0
Brake	0	0	0	0	1	1	1
open Front coupler	0	0	0	0	1	0	1
open Rear coupler	0	0	0	0	1	1	0
blow Horn 1	0	0	1	1	1	0	0
ring Bell	0	0	1	1	1	0	1
letoff sound	0	0	1	1	1	1	0
blow Horn 2	0	0	1	1	1	1	1
AUX1 off	0	0	0	1	0	0	0
AUX1 option 1 (CAB AUX1 button)	0	0	0	1	0	0	1
AUX1 option 2	0	0	0	1	0	1	0
AUX1 on	0	0	0	1	0	1	1
AUX2 off	0	0	0	1	1	0	0
AUX2 option 1 (CAB AUX2 button)	0	0	0	1	1	0	1
AUX2 option 2	0	0	0	1	1	1	0
AUX2 on	0	0	0	1	1	1	1
Numeric N (D=command number 0-9)	0	0	1	D	D	D	D



# Base-computer communications

## Command set (continued)

<i>Engine extended commands</i>	<i>Command field</i>		<i>Data field</i>				
	0	1	1	D	D	D	D
assign to Train (D=train address)	0	1	1	D	D	D	D
assign as single unit forward direction	0	1	0	0	0	0	0
assign as single unit reverse direction	0	1	0	0	1	0	0
assign as head-end unit forward direction	0	1	0	0	0	0	1
assign as head-end unit reverse direction	0	1	0	0	1	0	1
assign as middle unit forward direction	0	1	0	0	0	1	0
assign as middle unit reverse direction	0	1	0	0	1	1	0
assign as rear unit forward direction	0	1	0	0	0	1	1
assign as rear unit reverse direction	0	1	0	0	1	1	1
set Momentum low	0	1	0	1	0	0	0
set Momentum medium	0	1	0	1	0	0	1
set Momentum high	0	1	0	1	0	1	0
set address	0	1	0	1	0	1	1

<i>Train extended commands</i>	<i>Command field</i>		<i>Data field</i>				
	0	1	0	1	0	0	0
set Momentum low	0	1	0	1	0	0	0
set Momentum medium	0	1	0	1	0	0	1
set Momentum high	0	1	0	1	0	1	0
set address	0	1	0	1	0	1	1
clear lash-up	0	1	0	1	1	0	0

<i>Engine or Train speed commands</i>	<i>Command field</i>		<i>Data field</i>				
	1	1	D	D	D	D	D
set absolute speed (D=0-1F)	1	1	D	D	D	D	D
change speed relative (D=relative speed)	1	0	D	D	D	D	D
D = A = +5 D = 9 = +4 ... D = 5 = 0 (no change) ... D = 0 = -5							

<i>Accessory action commands</i>	<i>Command field</i>		<i>Data field</i>				
AUX1 off	0	0	0	1	0	0	0
AUX1 option 1	0	0	0	1	0	0	1
AUX1 option 2	0	0	0	1	0	1	0
AUX1 on	0	0	0	1	0	1	1
AUX2 off	0	0	0	1	1	0	0
AUX2 option 1	0	0	0	1	1	0	1
AUX2 option 2	0	0	0	1	1	1	1
AUX2 on	0	0	0	1	1	1	1
numeric command (D=command number 0-9)	0	0	1	D	D	D	D

<i>Accessory extended commands</i>	<i>Command field</i>		<i>Data field</i>				
all off	0	1	0	0	0	0	0
all on	0	1	0	1	1	1	1
set address	0	1	0	1	0	1	1
assign AUX1 to group (D=group address)	0	1	0	D	D	D	D
assign AUX2 to group (D=group address)	0	1	0	D	D	D	D

<i>Group commands</i>	<i>Command field</i>		<i>Data field</i>				
off	0	0	0	1	0	0	0
option 1	0	0	0	1	0	0	1
option 2	0	0	0	1	0	1	1
on	0	0	0	1	0	1	1
clear	0	1	0	1	1	0	0

**System halt command**

1	1	1	1	1	1	1	1	1	1	1	1	1	1	1	1	1
---	---	---	---	---	---	---	---	---	---	---	---	---	---	---	---	---

**System NOP command**

1	1	1	1	1	1	1	1	1	0	0	0	0	0	0	0	0
---	---	---	---	---	---	---	---	---	---	---	---	---	---	---	---	---

**System reserved command**

1	1	1	1	1	1	1	0	1	1	1	1	1	1	1	1	1
---	---	---	---	---	---	---	---	---	---	---	---	---	---	---	---	---

**System reserved command**

1	1	1	1	1	1	1	1	1	1	1	1	1	1	1	1	0
---	---	---	---	---	---	---	---	---	---	---	---	---	---	---	---	---

# Base-computer communications

## Examples

---

The following examples are given to illustrate proper command usage.

**Example One: throw switch #27 OUT**

0	1	0	0	1	1	0	1	1	0	0	1	1	1	1	1
---	---	---	---	---	---	---	---	---	---	---	---	---	---	---	---

**Example Two: blow horn 1 for Train #4**

1	1	0	0	1	0	1	0	0	0	0	1	1	1	0	0
---	---	---	---	---	---	---	---	---	---	---	---	---	---	---	---

**Example Three: increase the speed of Engine #2 by three steps**

0	0	0	0	0	0	0	1	0	1	0	0	1	0	0	0
---	---	---	---	---	---	---	---	---	---	---	---	---	---	---	---

# Problemsolving

## Answers to questions

***Everything is connected, but nothing's happening.***

- Check all power connections to PowerHouse, PowerMaster(s), and the Command Base. Make sure each component's "on" lamp is illuminated. Make sure the circuit breakers on the PowerHouses are not tripped; reset them as necessary. Verify track voltage with a test light. If all connections are secure and a lamp does not illuminate, contact your Lionel TrainMaster Service Station for assistance.

***The Command Base's green light is off.***

- Make sure the wallpack is properly plugged in. Check the wallpack power wire to ensure it is snug in the Command Base's input. The green light should illuminate.

***PowerMaster's green light is off.***

- Plug in PowerHouse and turn it on. Check PowerHouse's circuit breaker; push it in if it's been triggered.
- Make sure PowerHouse's power cable is secured firmly in PowerMaster's input; the green light should illuminate.

***PowerMaster's green light is flashing.***

- There is/was a short-circuit across the track to which PowerMaster is supply electricity. Check for derailments or other short circuits. Reset PowerMaster: TR, ID#, BOOST.
- If you are in conventional mode, turn the throttle up.
- If you attempt a PowerMaster reset by pressing BOOST and nothing happens, reprogram PowerMaster: slide its RUN/PGM switch to PGM, press TR, and the PowerMaster ID#. Slide the switch to RUN. Press BOOST. PowerMaster has been reset. (CAB-1 remembers it's talking to this TR.)
- Turn PowerHouse off and on again.

***PowerMaster's red light doesn't blink when I send CAB-1 commands.***

- PowerMaster's red light will only blink when you directly address the PowerMaster with a TR command. Otherwise, all communications from CAB-1 are received by the Command Base; its red light will blink in response to CAB-1 communications.
- Relocate PowerMaster. CAB-1's communications may be impeded by structural or electronic elements in the area. Be sure PowerMaster is not sitting on a metal surface.
- Ensure PowerMaster's crystal is firmly seated. Also check the crystal in CAB-1: address other PowerMasters on your railroad by pressing TR and the PowerMasters' ID#. If they respond, check the first PowerMaster. See the TrainMaster Owner's Manual for additional information on crystals.

***The Command Base's red light doesn't blink when I send CAB-1 commands.***

- Try a new location for the Command Base; CAB-1 communications are not being properly received. Press WSTL/HRN and watch the red light for response (it should blink).
- Avoid metal surfaces when installing the Command Base. Metal detunes the Base's antenna and causes poor reception. If you must use a metal table or shelf, place a nonmetallic spacer at least 2" in height between the Base and surface.
- Check CAB-1's alkaline batteries. Remove one battery, then reinstall it. Make sure batteries are fresh and properly installed. You should hear a small "clicking" sound with every button press.
- Extend CAB-1's telescoping antenna completely.
- Turn off any interfering electronic devices in your railroad area: televisions, computers, and CB radios.
- Check the frequency crystals inside CAB-1 and the Command Base. They should be installed with a snug fit.



# Problemsolving

## Answers to questions (continued)

***I programmed my ENG ID, but the engine won't move.***

- Make sure the red light is blinking on the Command Base when you send CAB-1 commands. This says your CAB-1 commands are being received by the Command Base.
- Check your wiring connection between the Base and either your PowerMaster or common rails. The Base's communications wire should be attached to the common (U) binding post on PowerMaster or the outside rails.
- Make sure no derailments have occurred (PowerMaster's green light will be flashing if a derailment has occurred). Reset PowerMaster by pressing TR, its ID#, and BOOST.
- Make sure your track has power by using a test light—for example, an illuminated freight or passenger car.
- Check PowerHouse's circuit breaker. Reset if necessary.
- Make certain there are no connections between your railroad and either earth ground or power-line ground.
- Reprogram the locomotive's ID#. Slide the reverse unit program switch to the middle on diesels, the rear on steam locomotives. Put the locomotive on unpowered track. Make sure the Command Base is on. Power up your track. Now, press ENG, the locomotive's ID#, and SET. The horn or whistle should sound, indicating receipt of the new programming. Slide the reverse unit program switch back to FORWARD. Press ENG and the ID#, WSTL/HRN or turn the throttle. Your locomotive should respond.

***I turned the throttle but my locomotive doesn't respond.***

- CAB-1 may be asleep. Press BOOST to wake it up.
- Readdress the locomotive: press ENG and its ID number. It should now respond to any command button press or throttle change.

***My locomotive is acting kind of strange. How can I reset it?***

- Press AUX1 and 0 on the keypad. This resets your locomotive and cycles the LCRU to forward.
- Shut down the PowerMaster or transformer supplying power to the locomotive for 10 seconds after Railsounds II shuts down. This restarts the computer inside your locomotive.

***I want to run my conventional locomotives, but they take off at full speed.***

- Set the PowerMaster controlling your conventional locomotive's track to CONV. This changes track voltage from constant (18 volts) to variable, allowing for the operation of conventional locomotives—transitional command control.
- Address the track your conventional locomotive is occupying. Press TR and the PowerMaster's ID number. Turn the throttle or press a command button. Your conventional locomotive should respond.
- Check PowerMaster output with a test light.
- You can only operate one conventional train per PowerMaster.

***I'm running one conventional locomotive and a few Command-equipped engines at the same time, but they're all running slowly.***

- When you operate in transitional command control, the track power level selected for the conventional locomotive (in essence, its "speed") is also the maximum voltage available to all Command-equipped locomotives addressed and in action. To increase the maximum speed potential of all locomotives in operation, address the track by pressing TR, the PowerMaster's ID#. Increase track voltage by turning the throttle up. The conventional locomotive's speed will increase, and all Command-equipped locomotives in action now have a higher maximum operating speed as well.

***My locomotive takes forever when I throttle it up.***

- Reset its momentum to LOW. The LCRU remembers the momentum setting until you change it.
- Make sure enough power is being applied to the track. Address the PowerMaster controlling that block of track and set its output to maximum. Hint: use a small test light.

***Why is there no neutral?***

***I built a consist with two locomotives, but it won't respond when I press TR and its ID number.***

***The locomotives in my consist seem to fight each other.***

***I want one of the locomotives in my consist to face "backwards." How can I do that?***

***Whenever I operate my consist, the circuit breaker on my PowerHouse trips.***

***The locomotives in my consist all seem to start differently, even though I set the stall voltage for the consist.***

***I connected my switches to SC-1, but I can't get the switches to throw.***

***I programmed switch numbers for every SC-1, but now I can't remember which switch is which!***

***When I address a switch and press AUX1 to make it go straight, it throws to the curve.***

***I connected my culvert loader to SC-1, but it stays on even after I release AUX1.***

- You don't need neutral in command control. A Command-equipped locomotive doesn't move until it's been addressed, so the "neutral" state in the reverse unit isn't necessary. If you want a locomotive to stay put as if in neutral, simply stop it and select another locomotive.
- Carefully repeat the consist set-up sequence.
- Make sure you selected a TRAIN (TR) ID# that doesn't identify a PowerMaster or another TRAIN consist on your railroad.
- Reset the consist's direction: press TR, the train's ID#, AUX1, and 0. This signals the LCRUs in the consist to begin operating in their "normal" TRAIN start direction.
- Set ALL reverse unit control switches are to FORWARD.
- Reprogram the contrary engine with or without the DIR button command during the consist build sequence.
- Include the DIR command in your consist programming string. For example, if your F3 #89 is to be the "rear" engine in the consist facing backward, press TR, the consist ID#, 89, R, DIR, and SET. This tells the F3's LCRU that it should operate in "reverse" during "forward" consist operations.
- Try reducing the number of motors in the consist. Generally speaking, two to three dual-motored locomotives (four to six motors total) is the limit for a single PowerHouse.
- Make sure you don't have two TRAINS with the same ID#.
- If you're operating differing locomotives in a consist (for example, a postwar F3, MPC Geep, and LTI RS3), each locomotive will start at a different voltage threshold. Try fine-tuning the stall voltage for the consist by setting individual stall voltages for each locomotive. See "Tuning consist performance."
- You must program the SC-1 with switch addresses before you can operate the switches.
- Verify the switch is receiving power by making sure SC-1's green light is on.
- Place numbered "flags" or stickers at each switch. This will help you remember switch numbers; later, you can remove them. A layout diagram with numbered switch locations can also help. Small divisional diagrams positioned around a large layout's perimeter can provide another solution.
- Reverse the "outer" wires (those connected to the two outside binding posts on 022 and O-72 switches) either at the switch or at SC-1.
- The accessory is incorrectly connected to an on/off terminal on SC-1—the lower terminals. Connect the accessory's lead to the upper SC-1 accessory terminals; these are for momentary functions. Note: SC-1 remembers the on/off status of accessories after layout power has been turned off.

# Problemsolving

## Answers to questions (continued)

---

***I incorrectly entered some information when programming a RTE. What should I do?***

***I added a switch to a route that I don't really want. How can I remove it?***

***My train derailed and I want to shut down its track—but I don't want to deactivate the entire layout.***

***After fixing a derailment (or experiencing an accidental power interrupt), my locomotive runs fine—but Railsounds II isn't responding to CAB-1 commands.***

***After fixing a derailment (or experiencing an accidental power interrupt), my diesel's Railsounds II is still on—at full RPMs—and won't shut off.***

***My kid likes running trains, but she runs 'em too fast. Is there anything I can do?***

***Bulbs keep burning out all over my railroad. Help!***

- Making errors during route programming is no big deal. Just remember that as long as you don't press SET, you haven't programmed anything. Start over at the RTE command for that particular switch: RTE, route ID#, RTE, route ID#, the switch number, the direction you want the switch to throw (AUX1 or AUX2), and finally, SET. Pressing SET commits the command string to memory. If you pressed SET already, read on.
- You must clear the entire route and reprogram it. Press RTE, route ID#, RTE, route ID#, and SET. This erases all switch assignments in the route.
- Shut down the PowerMaster controlling that block of track: press TR, the PowerMaster's ID#, AUX1, and 0. To reactivate PowerMaster, press TR, its ID#, and BOOST.
- After a derailment has been corrected, your Command-equipped Lionel may work normally though Railsounds II does not fully respond to CAB-1 button commands. Reboot the Railsounds II computer by removing *all* power from the track, wait for Railsounds II to completely shut down, then wait 5 more seconds. Power up the track again, address the locomotive, and full Railsounds II performance should be restored.
- Power up your track. The Railsounds II computer in your Command-equipped Lionel diesel will return to idle and is ready for operation.
- Set a maximum voltage output for every PowerMaster installed on your railroad. Slide the COMM/CONV switch to CONV. Press TR, the PowerMaster's ID number, and throttle up to the maximum desired speed. Restore the full speed range by pressing TR, the PowerMaster's ID number, and throttling up to the maximum voltage setting.
- If you're using a Lionel ZW, back off on its output.
- Light bulbs powered by constant voltage may burn out quicker than those receiving variable voltage during conventional operations. Replace them with higher-voltage bulbs; see the Bulb Replacement Chart for more information.



## Phasing power supplies

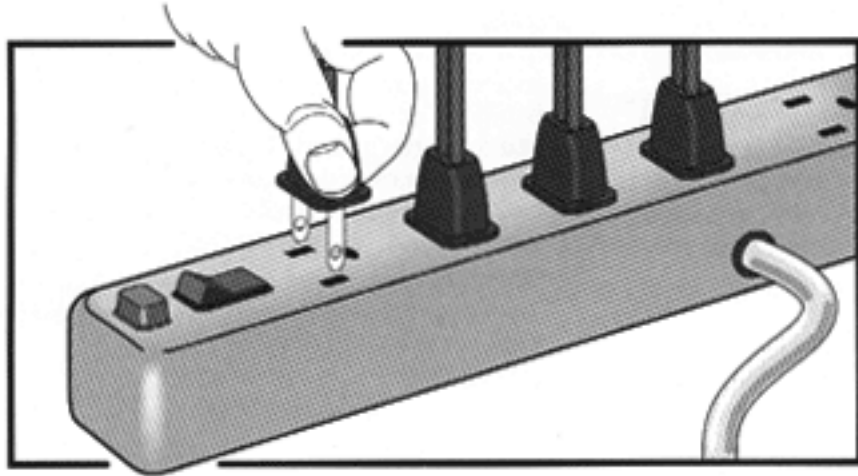

The easiest way to phase power supplies is by using a properly grounded power strip with circuit breaker.

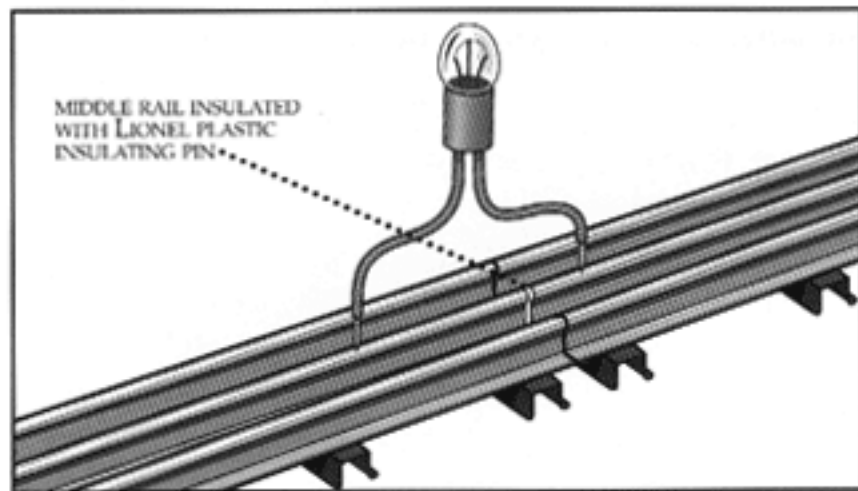

An alternate method for phasing power sources is by using a test lamp or voltmeter. With both sources on full output, connect a test lamp to the A terminals on PowerMaster or the two isolated center rails on the adjoining blocks. Dim or dark lamp=proper phasing.

A model railroad with isolated blocks powered by multiple transformers must be "phased"—where the output of each power supply "matches" one another. "Phased" electricity eliminates excess sparking and short circuiting as locomotives pass from one block to another. Phasing is nothing more than plugging everything in the same way.

The easiest way to phase multiple PowerMaster-PowerHouse pairs on your railroad is by using a multi-outlet power strip (available at hardware stores). If you elect to not use a power strip or are using standard transformers, you must phase each power supply. Remove all locomotives from your layout and turn on all PowerHouses or transformers (transformers on full). Make sure each PowerMaster has identical track connections (center rail to the A terminal, outer rail to U). Ensure the center rails at block boundaries are insulated with Lionel plastic insulating pins.

Slide each PowerMaster's CMD/CONV switch to CMD. Connect a test light or voltmeter between the A terminals on the first and second PowerMasters. You can also connect the light or voltmeter between two isolated center rails electrified by two PowerMasters. If the light is off or dim, the two PowerMasters are in phase. However, if the light is brilliant or the voltmeter reads 30 volts or more, one of the PowerHouse/transformer plugs is "backwards." Reverse the plug (rotate it 180°) at the outlet. Check again; the light should be off or dim. Repeat at each PowerMaster junction. If you have three-phase power, make sure everything is on the same phase as the Command Base.

## For more information

**Lionel TrainMaster Command  
technical support line**

**1-800-727-7297**

**Monday through Friday  
8 a.m. to 5 p.m. Eastern Time**

We want your experience with Lionel TrainMaster Command to be the best. If you've been through the Answers to Questions and still can't get your TrainMaster Command system operating to your satisfaction, please call our technical support line. We're ready to answer *all* your TrainMaster-related questions.



# Glossary

## The language of command control

### **accessory**

Any operating accessory produced by Lionel, American Flyer, or Marx.

### **address**

To "call" a device using a numeric name, known as an "ID#."

### **address buttons**

The top row of buttons on CAB-1 that selects various locomotive and layout elements. Addresses include switch (SW), accessory (ACC), route (RTE), track and train (TR), and engine (ENG).

### **Big Red**

The pressure-sensitive control button that plugs into CAB-1. Designed for use by young children and those with physical disabilities. Pressing Big Red duplicates the last command issued by CAB-1.

### **block**

An electrically isolated section of Lionel track, separated from the normal flow of transformer-supplied voltage by the presence of plastic insulating pins located in the center rail at either end of the block.

### **block control**

A form of model railroad locomotive control that uses electrically isolated blocks and manually or automatically controls the distribution of power.

### **CAB-1**

The handheld remote control for the TrainMaster Command model railroad control system.

### **coil couplers**

Operating locomotive couplers that feature an electromagnetic coil. When energized, the coil opens the coupler without the aid of a remote uncoupling session.

### **Command Base**

The TrainMaster Command component that generates digital communications in response to CAB-1 commands and narrowcasts its communications on the common (outside) rails of any Lionel railroad.

### **command buttons**

The large buttons on CAB-1 that control locomotive functions. Command buttons include whistle/horn, bell, direction, boost, brake, coupler front and rear, and AUX1/AUX2.

### **command control**

A method for controlling model locomotives that involves the simultaneous operation of multiple locomotives; also includes total layout control (switches, accessories, and more). In TrainMaster Command, command control involves the use of digital signalling on the track which is picked up by specially equipped locomotives, enabling the locomotives to perform individually on the same track without complicated wiring schemes.

### **Command-equipped**

A description that means a locomotive is outfitted with a Liontech Command reverse unit (LCRU). Command-equipped locomo-

tives run in both TrainMaster Command and conventional operating environments.

### **constant (continuous) voltage**

A steady application of electricity applied to the track. In command control, constant voltage is usually in the 18-volt range. Only locomotives equipped with Liontech Command Reverse Units will operate properly in a constant voltage environment.

### **conventional operations**

The traditional way of running Lionel trains—track power up, the locomotive moves; track power down, the locomotive stops. Generally involves the operation of only one locomotive at a time.

### **crystal**

The radio-frequency element that causes CAB-1 to broadcast on a certain frequency—and PowerMaster and the Command Base to receive signals on a certain frequency.

### **division**

A large, electrically isolated section of model railroad. Usually encompasses a number of electrically isolated PowerMasters with the same ID#. This ID# is known as the "division number."

### **ground**

The "common" or return electrical pathway after passing through an electrical device. Ground is the electrical pathway that must be connected to SC-1 for proper operation.

### **hot**

The direct pathway of electricity that first passes through an electrical device. The side of a transformer that is not connected to track ground. Never connect a hot lead to SC-1 or damage will occur.

### **ID#**

The one- or two-digit number that helps identify a locomotive, switch, accessory, PowerMaster, etc. to the Command Base or SC-1 when issuing commands with CAB-1.

### **lash-up**

A multi-locomotive set; consist.

### **LCRU**

The Liontech Command reverse unit, an onboard computer that enables a locomotive to operate in both conventional and Command environments.

### **momentum**

A locomotive behavior that simulates the performance of a real-life engine laboring under load.

### **neutral**

The nonmoving operational state in a three-position reverse unit. When operating in the TrainMaster Command environment, Command-equipped locomotives do not have a "neutral" state like they do in conventional realms.

### **numeric keypad**

The 10-digit (0-9) section of the CAB-1 layout that allows you to issue ID#s as well as special locomotive commands when preceded by a press of AUX1.

### **phasing**

The act of "matching" power applied to a model railroad. When a railroad features multiple power supplies, each supply's output must be "phased" at block boundaries to prevent excess third-rail sparking and digital communications problems during operation.

### **Powerhouse**

The TrainMaster component that provides power to your PowerMaster.

### **PowerMaster**

The TrainMaster component that controls power distribution on a TrainMaster Command railroad.

### **reverse unit control switch**

The two- (steam) or three- (diesel) position switch on Command-equipped locomotives that controls programming and first-start direction. One switch setting is for programming ID#s, the other(s) for selecting forward or reverse start.

### **route**

A multi-switch pathway around your railroad. Switches thrown in select directions cause a train to proceed around a layout in a specific way—a route.

### **SC-1**

The TrainMaster Command digital terminal that controls switch and accessory operation; each SC-1 controls four switches and two accessories.

### **stall (conventional reverse unit)**

A voltage level that is not enough to energize a locomotive's motor into movement but is enough to keep that locomotive's reverse unit from sequencing to the next operational state.

### **stall (command LCRU)**

A voltage level used to tune engine performance and to match lash-up start thresholds among differing locomotive types.

### **switch**

A section of railroad track that allows one track to diverge into two—or combines two tracks into one. Also called a "turnout."

### **throttle**

The Circle-L knob on CAB-1 that controls locomotive speed and PowerMaster voltage output settings.

### **transitional command control**

A way of operating TrainMaster Command that retains the digital signalling required for individual locomotive control but foregoes continuous track voltage in favor of variable track power, as in conventional operations. Variable power allows for the operation of non-Command-equipped engines.

### **turnout**

A railroad switch.

### **ZW**

A high-output alternating-current transformer produced by the Lionel Corporation from 1948-1969; sufficient power for TrainMaster Command railroads.

## A

- Accessories**
- Accessory Supplement 15
- automatic ID# assignment 16
- connecting to SC-1 15
- programming ID#s 16
- controlling with CAB-1 16
- powering SC-1 with a wall-pack for accessory-only operation 15
- momentary functions 15,16
- on/off (toggle) functions 15,16
- modifying 15
- labeling terminals 15
- ACC address button 16
- addressing**
- locomotives 8
- switches 11
- accessories 16
- routes 13, 14
- lash-ups 22, 24
- applying track power 6
- Advanced operating techniques** 22
- air whistles, modifying 34
- Answers to questions** 41
- auxilliary lights (lash-ups) 23, 25
- auxilliary lights (engines) 9

## B

- Base, Command *see* Command Base
- basic commands
- sending with CAB-1 8
- bell command (lash-ups) 24
- bell command (engines) 8
- boost command (lash-ups) 24
- boost command (engines) 8
- block control
- ensuring continuous common rail communication 5
- brake command (lash-ups) 24
- brake command (engines) 8
- bulb replacement 4, 34
- bumpers, track 34

## C

- circuit breaker tripping 26

- Command Base**
- installing 5
- leaving on 5
- connecting to your railroad 5
- using with a power strip 5
- Command control operations** 6
- Command-equipped locomotives**
- programming ID#s 7
- addressing 8
- basic commands 8
- tuning performance 9
- numeric commands 9
- computer commands 36
- constant voltage 4
- conventional operations 28,30
- conventional locomotives 28,30
- couplers
- coupler command (engine) 8
- coupler command (lash-up) 24
- cutting track power 6

## D

- derailments, fixing 17
- digital communications, from Command Base 6
- direction (lash-ups) 24
- direction (engines) 8
- dual-motored locomotives 26

## E

- emergency stops (halt) 8, 17, 24

## F

- firebox glow (lash-ups) 25
- firebox glow (engines) 9
- fixed-voltage plugs, switches 10
- full voltage range, restoring 18

## G

- Glossary** 46
- grouping TRACK ID#s 21

## H

- halt and reset (lash-ups) 25
- halt and reset (engines) 8, 9
- halt command 8, 24
- headlights (lash-ups) 25
- headlights (engines) 9
- help, toll-free line** 45
- horn command (engines) 8
- horn command (lash-ups) 24

## I

- ID#s**
- assigning to locomotives 7
- assigning to switches 11
- assigning to accessories 16
- assigning to routes 13
- idle, RPMs (lash-ups) 25
- idle, RPMs (engines) 9
- information, additional 39
- interference, between CAB-1 and the Command Base or PowerMaster 48

## L

- lash-ups**
- addressing 24
- building 22
- basic commands 24
- clearing lash-ups 27
- lash-up notes 27
- numeric commands 25
- problemsolving 26
- removing engines 25
- tuning performance 27
- Layout modifications** 34
- Leaving the Base on 5
- Liontech Command reverse unit (LCRU)
- sensing digital communications 6
- defaulting to conventional operations 6
- locomotives, addressing 8
- lowering volume (lash-ups) 25
- lowering RPMs (lash-ups) 25
- lowering volume (engines) 9
- lowering RPMs (engines) 9

## M

- maximum voltage levels 18

- modern steam tenders, modifying 34
- modifications, layout 34
- momentum (engines) 9
- momentum (lash-ups) 27
- multiple PowerMaster installations 19, 20, 21

## N

- neutral (the lack thereof) 8, 24
- Numeric commands
- sending to locomotives 9
- sending to lash-ups 25

## O

- Operating accessories
- see* Accessories
- operating cars, modifying 34
- out of sync locomotives 26
- out (switch direction) 10, 12

## P

- passenger cars, modifying 34
- Phasing power supplies** 45
- powering up a track 6
- powering down a track 6
- PowerMaster**
- controlling track power 17
- limiting output 18
- powering down individual tracks 18
- restoring power to individual tracks 17
- using PowerMaster in multiple-unit installations 19,20,21
- Preparing your railroad for TrainMaster Command 4
- Problemsolving** 41

## R

- Railsounds II (lash-ups)
- activating 24, 25
- lowering RPMs 25
- lowering volume 25
- raising RPMs 25
- raising volume 25
- resetting to auto RPMs 25

shutting down	25
Railsounds II (engines)	
activating	8, 9
lowering RPMs	9
lowering volume	9
raising RPMs	9
raising volume	9
resetting to auto RPMs	9
shutting down	9
raising RPMs (lash-ups)	25
raising RPMs (engines)	9
raising volume (lash-ups)	25
raising volume (engines)	9
<b>Recommended layout</b>	
<b>  modifications</b>	34
removing locomotives	
from lash-ups	25
reset (lash-ups)	25
reset (engines)	9
reset Railsounds II (lash-up)	25
reset Railsounds II (engines)	9
restoring track power	6, 17
reverse unit control switch	
programming ID#s	7
lash-up troubleshooting	23, 26
<b>Routes</b>	
adding switches	13
creating	13
clearing (erasing)	14
checking RTEs	13
correcting RTE errors	14
<b>S</b>	
<b>SC-1</b>	
connecting to switches	10
connecting to accessories	15
labeling terminals	10, 15
prime locations for SC-1	10
RUN/PGM switch	11, 16
using a wallpack	15
wiring terminals	10
serial port (Base)	36
short circuits, removing	4
shutdown sequence,	
Railsounds II (lash-ups)	25
shutdown sequence,	
Railsounds II (engines)	9
single-motored locomotives	26
smoking cabooses	34
stall (engines)	9

stall (lash-ups)	27
start-up sequence,	
Railsounds II (consists)	25
start-up sequence,	
Railsounds II (engines)	9
"Sticky" keys	32
SW address button	11
<b>Switches</b>	
clearing routes	14
connecting to SC-1	10
controlling with CAB-1	12
creating routes	13
modifications	34
programming ID#s	11
switch terminals	10

## T

TRACK ID#s, grouping	21
TRAIN address button	22
throttle (consists)	24
throttle (engines)	8
through (switch direction)	12
track bumpers	34
<b>Transitional command</b>	
<b>  control with ZWs</b>	28
<b>  control with PM-1s</b>	30
<b>Tuning locomotive</b>	
<b>  performance</b>	9

## U

UCS sections	15, 34
--------------	--------

## V

volume (lash-ups)	25
volume (engines)	9

## W

wallpack, Command Base	5
wallpack, SC-1	15
whistle command (lash-up)	24
whistle command (engines)	8
wiring the Command Base to	
your railroad	5

## Z

<b>ZW</b>	
enhancing locomotive perfor-	
mance with ZWs	18, 19
reducing ZW output	18, 19

## FCC statement

The Lionel Command Base is covered by FCC rules for a Class B computing device. As required by FCC regulations, the following is provided for the information and guidance of the user.

This equipment has been tested and found to comply with the limits for a Class B digital device, pursuant to Part 15 of the FCC Rules. These limits are designed to provide reasonable protection against harmful interference in a residential installation. This equipment generates, uses, and can radiate radio frequency energy. If not installed and used in accordance with the instructions, it can cause harmful interference to radio communications. However, there is no guarantee that interference will not occur in a particular installation. Determine if the equipment does cause interference to radio or television reception by turning the equipment off and on. The user is encouraged to try to correct the interference by one or more of the following measures: (1) Where it can be done safely, reorient or relocate the receiving antenna (Base); (2) Increase the separation between the equipment and receiver; (3) Connect the equipment into an outlet on a circuit different from that to which the receiver is connected; and (4) Consult your Lionel dealer or an experienced radio/TV technician for help.

Changes or modifications not expressly approved by Lionel Trains Inc. could void the user's authority to operate the equipment.



© 1995 Lionel Trains Inc.  
50625 Richard W. Blvd.  
Chesterfield, MI 48051-2493

Lionel and TrainMaster are registered trademarks and Command, PowerHouse, PowerMaster, CAB-1, SC-1, ZW, and Railsounds II are trademarks of Lionel Trains Inc. Big Red is a registered trademark of AbleNet Inc. and is used with permission.